

NOTICE OF CONSTRUCTION APPLICATION
Raymond CDK Upgrades



Weyerhaeuser, Inc. / Raymond, WA

Prepared By:

Beth Ryder – Managing Consultant
Nancy Liang – Managing Consultant
Maddie Coates – Consultant
Matt Goldman – Consultant

TRINITY CONSULTANTS

20819 72nd Avenue South
Suite 610
Kent, WA 98032
(253) 867-5600

August 2023

Project 224801.0117



TABLE OF CONTENTS

1. EXECUTIVE SUMMARY	1-1
2. PROJECT DESCRIPTION	2-1
2.1 New and Modified Equipment	2-2
2.1.1 Continuous Dry Kiln	2-2
2.1.2 Bark and Chip Bins	2-2
2.1.3 Green Sawdust Transfer	2-3
2.1.4 Haul Roads	2-3
2.2 Existing Unit Shutdowns	2-3
3. EMISSION CALCULATIONS	3-1
3.1 Continuous Dry Kiln	3-1
3.1.1 Fuel-Based Emissions	3-1
3.1.2 Species-Based Emissions	3-1
3.1.3 Fuel- and Species-Based Emissions	3-1
3.2 Material Handling	3-2
3.2.1 Emissions Controlled by Cyclones and Baghouse	3-2
3.2.2 Fugitive Emissions	3-2
3.3 Haul Roads	3-3
3.4 Project- and Facility-Wide Emissions	3-3
4. REGULATORY APPLICABILITY	4-1
4.1 NOC Permitting Applicability	4-1
4.2 Best Available Control Technology (BACT)	4-1
4.3 Prevention of Significant Deterioration (PSD)	4-2
4.4 Title V Operating Permit Program	4-2
4.5 New Source Performance Standards (NSPS)	4-2
4.5.1 40 CFR 60 Subpart A – General Provisions	4-2
4.5.2 40 CFR 60 Subparts D, Db, Dc – Standards of Performance for Steam Generating Units	4-2
4.5.3 40 CFR 60 Subpart CCCC – Standards of Performance for Commercial and Industrial Solid Waste Incineration Units	4-3
4.6 National Emission Standards for Hazardous Air Pollutants (NESHAP)	4-4
4.6.1 40 CFR 63 Subpart A – General Provisions	4-4
4.6.2 40 CFR 63 Subpart DDDD – National Emission Standards for Hazardous Air Pollutants: Plywood and Composite Wood Products	4-4
4.6.3 40 CFR 63 Subpart DDDDD – National Emission Standards for Hazardous Air Pollutants for Major Sources: Industrial, Commercial, and Institutional Boilers and Process Heaters	4-5
4.6.4 40 CFR 63 Subpart JJJJJ – National Emission Standards for Hazardous Air Pollutants for Industrial, Commercial, and Institutional Boilers Area Sources	4-6
4.7 State Regulatory Applicability	4-6
4.7.1 Washington Toxic Air Pollutant Regulations	4-6
4.7.2 General Emissions Standards and Practices	4-6
4.8 Local Regulatory Applicability	4-8
4.8.1 General Emissions Standards and Practices	4-8
4.8.2 ORCAA Rule 8.1 – Wood Heating	4-8
5. BEST AVAILABLE CONTROL TECHNOLOGY	5-1

5.1	BACT Methodology	5-1
5.1.1	Step 1 – Identify All Control Technologies.....	5-1
5.1.2	Step 2 – Eliminate Technically Infeasible Options	5-1
5.1.3	Step 3 – Rank Remaining Control Technologies by Control Effectiveness.....	5-1
5.1.4	Step 4 – Evaluate Most Effective Controls and Document Results	5-1
5.1.5	Step 5 – Select BACT	5-2
5.2	BACT Analysis for New CDK	5-2
5.2.1	BACT Analysis for VOC Emissions	5-2
5.2.2	BACT Analysis for PM Emissions	5-7
5.2.3	BACT Analysis for CO Emissions	5-1
5.2.4	BACT Analysis for NO _x Emissions.....	5-2
5.2.5	BACT Analysis for SO ₂ Emissions.....	5-3
5.2.6	tBACT Analysis for Toxic Air Pollutant Emissions.....	5-4
5.3	BACT Analysis for Paved Roads	5-4
5.3.1	BACT Analysis for PM Emissions.....	5-4
5.4	BACT Analysis for Material Handling	5-5
5.4.1	BACT Analysis for PM Emissions.....	5-5
6.	MODELING METHODOLOGY	6-1
6.1	Model Selection	6-1
6.2	Meteorological Data	6-1
6.2.1	Surface Data	6-1
6.2.2	Upper Air Data.....	6-2
6.2.3	Land Use Analysis	6-2
6.2.4	AERMET Processing Options	6-4
6.3	Coordinate System	6-5
6.4	Terrain Elevations	6-5
6.5	Urban / Rural Determination	6-5
6.6	Receptor Grid	6-6
6.7	Building Downwash	6-8
6.8	Source Types and Parameters	6-8
7.	MODELING ANALYSIS	7-1
7.1	TAP Modeling	7-1
7.2	NAAQS Modeling	7-1
	APPENDIX A. APPLICATION FORMS	A-1
	APPENDIX B. SITE PLANS AND PROCESS FLOW DIAGRAM	B-1
	APPENDIX C. EQUIPMENT SPECIFICATIONS	C-1
	APPENDIX D. "EPD RECOMMENDED EMISSION FACTORS FOR LUMBER KILN PERMITTING IN GEORGIA"	D-1
	APPENDIX E. NCASI TECHNICAL BULLETIN NO. 1013: "A COMPREHENSIVE COMPILATION AND REVIEW OF WOOD-FIRED BOILER EMISSIONS"	E-1
	APPENDIX F. EMISSION CALCULATIONS	F-1
	APPENDIX G. MODEL PARAMETERS	G-1

APPENDIX H. CONCENTRATION PLOTS

H-1

APPENDIX I. MODEL FILES

I-1

LIST OF TABLES

Table 2-1. Permitted and Proposed Emission Units at the Facility	2-1
Table 3-1. Project Potential Emissions (tpy) — Criteria Pollutant Summary	3-3
Table 3-2. Project Potential Emissions — HAP/TAP Summary	3-4
Table 3-3. Facility-Wide Potential Emissions (tpy) — Criteria Pollutant Summary	3-5
Table 4-1. BACT Summary	4-1
Table 4-2. Emission Standards for Affected Sources	4-6
Table 5-1. RBLC Results for VOC Emissions from CDKs	5-3
Table 5-2. RBLC Results for PM Emissions from CDKs	5-8
Table 5-3. RBLC Results for CO Emissions from CDKs	5-1
Table 5-4. RBLC Results for NO _x Emissions from CDKs	5-2
Table 5-5. RBLC Results for SO ₂ Emissions from CDKs	5-4
Table 5-6. RBLC Results for PM Emissions from Paved Roads	5-5
Table 5-7. RBLC Results for PM Emissions from Material Handling	5-6
Table 6-1. AERSURFACE Input Parameters	6-3
Table 7-1. TAP Model Results	7-1
Table 7-2. Background Concentrations	7-2
Table 7-3. NAAQS Model Results	7-2

1. EXECUTIVE SUMMARY

Weyerhaeuser Company (Weyerhaeuser) owns and operates a softwood lumber mill in Raymond, Washington (the Facility). The Facility is located at 51 Ellis Street, Raymond, WA 98577. The Raymond mill currently operates under Olympic Region Clean Air Agency (ORCAA) Air Operating Permit (AOP) 12AOP915 in an attainment or unclassified area for all pollutants. The Facility currently produces kiln dried lumber using steam-heated batch kilns, and several other products from wood residuals generated in the milling process such as wood chips, sawdust, and shavings. The Facility is currently a Title V source with emissions of hazardous air pollutants (HAPs), carbon monoxide (CO), nitrogen oxides (NO_x), and volatile organic compounds (VOCs) above their corresponding Title V major source thresholds.

Weyerhaeuser is proposing the addition of one new continuous dry kiln (CDK) to replace the eight existing batch kilns used in the lumber drying process. While this project itself will generate emissions of all criteria pollutants and certain HAPs and Toxic Air Pollutants (TAPs) pollutants, post-project potential emissions of regulated pollutants will reduce below the Prevention of Significant Deterioration (PSD) thresholds. This report is submitted in fulfillment of the requirement to submit a Notice of Construction (NOC) application under ORCAA Rule 6.1. This report provides the relevant information required in ORCAA Rule 6.1.¹

The NOC application contains the following elements:

- ▶ Section 2: Project Description
- ▶ Section 3: Emission Calculations
- ▶ Section 4: Regulatory Applicability
- ▶ Section 5: Best Available Control Technology
- ▶ Section 6: Modeling Methodology
- ▶ Section 7: Modeling Analysis
- ▶ Appendix A: Application Forms
- ▶ Appendix B: Site Plans and Process Flow Diagram
- ▶ Appendix C: Equipment Specifications
- ▶ Appendix D: "EPD Recommended Emission Factors for Lumber Kiln Permitting in Georgia"
- ▶ Appendix E: NCASI Technical Bulletin No. 1013: "A Comprehensive Compilation and Review of Wood-Fired Boiler Emissions"
- ▶ Appendix F: Emission Calculations
- ▶ Appendix G: Model Parameters
- ▶ Appendix H: Concentration Plots
- ▶ Appendix I: Model Files

¹ A SEPA checklist has been included with this application in Appendix A, based on guidance from ORCAA.

2. PROJECT DESCRIPTION

Weyerhaeuser is proposing the installation of one new direct-fired CDK system with associated equipment and process changes (the Project) to replace the Facility's current eight batch kilns and hog fuel boiler. As a part of the Project, the Facility will move from processing both Hemlock and Douglas fir to only processing Douglas fir. Updated site maps and a process flow diagram (PFD) of the Project can be found in Appendix B of this report.

Table 2-1 presents a comparison of the Facility's emission units currently permitted in Table 4.2 of the Technical Support Document (TSD) for Permit 12AOP915 to the post-Project emission units.

Table 2-1. Permitted and Proposed Emission Units at the Facility

Pre-Project Emission Units	Description	Project Change	Post-Project Emission Units	Description
Wellons Boiler	Hog Fuel Boiler	Removed	--	--
Dry Kilns	Steam-Heated Batch Dry Kilns	Removed	--	--
Wood Waste Collection	Existing Cyclones	New/ Relocated	Wood Waste Collection	Existing Cyclones + Fuel Silo and Bark Cyclones + Relocated Dry Chip Cyclone with Baghouse
Fugitive Emissions - Roads	Haul Roads	Modified	Fugitive Emissions - Roads	Haul Roads
Log Debarking	Debarker	No Change	Log Debarking	Debarker
Truck Bins	Dry and Green Chip Bins	Removed	--	--
Wood Waste (e.g. hogged fuel)	Bark/Hog, Sawdust, Planer Shavings	Replaced	Chip and Bark Truck Bins	Truck Bins for Green Chips, Planer Shavings, Bark/Hog
--	--	New	Fugitive Emissions - Green Sawdust	Green Sawdust Sawmill Drop
--	--	New	CDK	Direct-Fired Continuous Dry Kiln

The following sections detail the proposed equipment additions and removals for the Project.

2.1 New and Modified Equipment

2.1.1 Continuous Dry Kiln

Continuous lumber drying kilns are an emerging technology that significantly improves productivity, lumber grade, and energy efficiency as compared to the operation of conventional steam-heated batch kilns. For example, much of the heat that is lost between batches in a traditional kiln when the doors open is retained within a continuous kiln. Since there is no downtime between batches, the continuous kiln remains at operating temperatures, which results in significant energy savings. Additional energy-recovery chambers are constructed on each end of the kiln heating chamber and a pusher system on each end conveys a continuous feed of lumber on one track into the kiln and on a second track in the opposite direction out of the kiln. The heat from the dried lumber coming out of the kiln preheats the green lumber entering the kiln on the second track, resulting in additional efficiency gains.

The operation is continuous and does not shut down except for unplanned malfunction events or planned maintenance outages. The continuous operating features result in improved energy efficiency and productivity of the lumber drying process. In addition, the moisture driven off the green lumber entering the kiln on one track conditions the dried lumber exiting the kiln heating chamber on the other track, resulting in improved product quality. The gasifier system will have an abort stack which will be closed and only used during periods of startup/shutdown, which is not expected to occur frequently based on the current system design. Vapor extraction modules will also be installed at each end of the CDK to reduce potential ground level fog hazards and send the majority of the water vapor upwards into the atmosphere.

The proposed CDK will have a capacity of 310 million board feet per year (310 MMBF/yr) and will process Douglas fir at a maximum drying temperature of 200 °F. Heat for the CDK will be provided by direct firing of green sawdust at a capacity of 50 million British thermal units per hour (50 MMBtu/hr). The following additional equipment will be installed with the CDK:

- ▶ One 40' (diameter) x 84' (height) fuel silo with unloaders and cyclone
- ▶ Cyclone
- ▶ Incline screw conveyor
- ▶ Metering bin
- ▶ Belt conveyor

CDK design specs are provided in Appendix C.

2.1.2 Bark and Chip Bins

Five 40-Unit truck bins will be installed onsite for storage of green lumber material—two bark bins and three chip bins. Green bark (also referred to as “hog fuel”) will be transferred by existing blow pipe from the hog unit to the cyclone on top of the bark bins. This cyclone is not a new unit, but rather is relocated from its present location just north of the fuel house in order to control particulate emissions from the bark transfer. Similarly, dry chips from the planer mill (also referred to as “planer shavings”) will be sent by blow pipe to the cyclone on top of the chip bins, which will also be relocated from just north of the fuel house. Exhaust from the chip bins cyclone will be routed to a new dry chip baghouse (design specs are located in Appendix C). The planer shavings will be mixed with green chips that are transferred from the Trimmer/Sorter/Stacker building to the chip bins via covered conveyor. To eliminate fugitive emissions, all conveyor drops are enclosed and cyclone loading into the truck bins is enclosed by airlock. The last

remaining transfer is truck loadout, where each bark and chip bin will be fitted with steel siding to minimize fugitive particulate emissions while loading the trucks.

2.1.3 Green Sawdust Transfer

As explained previously, green sawdust is used as the fuel for the CDK, and green sawdust generated in the sawmill will be transferred to the CDK fuel silo. Before green sawdust inside the sawmill's screens building is conveyed out of the enclosed space, a new diverter will divert sawdust from the green sawdust truck bin over to the fuel delivery surge bin. This diverter has an unenclosed drop via chutes, which generates fugitive emissions. After the diverter, green sawdust is transferred by covered conveyors and enclosed drops to the surge bin and then sent by blow pipe to the fuel silo cyclone, which exhausts to the atmosphere. As with the bark and chip bin cyclones, loadout into the silo is enclosed by an airlock. Green sawdust fuel is then transferred to the CDK burner via covered conveyors and enclosed drops.

Green sawdust generated in the sawmill is expected to be consumed in the CDK during normal operation. During infrequent CDK down time, such as cleaning, green sawdust generated in the sawmill may be stored in the green sawdust truck bin and sold.

2.1.4 Haul Roads

The Facility currently has paved roads in high-traffic areas, such as inbound/outbound shipping roads, the log yard, and the lumber/shipping areas for vendor traffic. With the CDK Project, about 538,700 ft² of land will be paved for various uses, such as chip and bark bin truck loading, green lumber holding and staging areas, product storage, and vehicle traffic. A map of the proposed paved land is attached to the report in Appendix B.

2.2 Existing Unit Shutdowns

The existing eight batch kilns are being decommissioned once the new continuous kiln is installed. After decommissioning, the kilns will be disassembled and the land will be paved over. Additionally, the proposed CDK will be directly fired, so the existing hog fuel boiler will no longer be necessary, and therefore will also be decommissioned.

Since the green chips and planer shavings will be transferred to new chip truck bins to be sold, the existing dry and green chip bins will be removed. Therefore, the "Truck Bins" emission unit from Table 2-1 will no longer exist. Similarly, the "Wood Waste (e.g. hogged fuel)" emission unit is also removed, since the hog fuel will be transferred to the bark bins for sale, as well as the new use for green sawdust as CDK fuel.

3. EMISSION CALCULATIONS

This section presents the methodology used to quantify pollutant emissions from the Project. Pollutants emitted from the Project include particulate matter (PM), particulate matter with an aerodynamic diameter less than 10 micron (PM₁₀), particulate matter with an aerodynamic diameter less than 2.5 micron (PM_{2.5}), sulfur dioxide (SO₂), oxides of nitrogen (NO_x), volatile organic compounds (VOC), carbon monoxide (CO), greenhouse gases (GHG) in the form of carbon dioxide equivalent (CO_{2e}), hazardous air pollutants (HAP), and toxic air pollutants (TAP).

3.1 Continuous Dry Kiln

As a direct-fired combustion unit, the CDK emits pollutants from the combustion of green sawdust and the drying of the wet wood product. There is no currently available data for direct-fired CDKs drying Douglas fir in the Pacific Northwest (PNW) region. Current data includes emission factors for direct-fired CDKs in the southern US, primarily drying southern pine, or indirect-heated batch kilns in the PNW, drying Douglas fir. However, one source cannot be used for all pollutants, since some pollutants are related to the fuel type and firing method (direct vs indirect, batch vs continuous), as compared to others that are related to wood species (e.g., Douglas fir), or even both fuel type and wood species. The following subsections detail the emission factors used in the calculation of CDK emissions from this Project.

3.1.1 Fuel-Based Emissions

Emissions of PM, PM₁₀, PM_{2.5}, CO, NO_x, and SO_x are dependent on the kiln's fuel type and firing method. Therefore, emissions are estimated using direct-fired continuous dry kiln emission factors from Georgia Environmental Protection Division's (EPD) document entitled "EPD Recommended Emission Factors for Lumber Kiln Permitting in Georgia", attached in Appendix D. For PM, PM₁₀, PM_{2.5}, CO, and NO_x, these emission factors are used in conjunction with the annual dried lumber production rate (310 MMBF/year), whereas for SO₂, the emission factor is used with the total kiln heat input (50 MMBtu/hr) and annual operating hours (8,400 hours/year). GHG emissions are calculated based on the total kiln heat input, annual operating hours, Global Warming Potentials (GWP) provided in Table A-1 of 40 CFR 98, and emission factors provided in Tables C-1 and C-2 for combustion of wood and wood residuals.

3.1.2 Species-Based Emissions

Emissions of VOC, acetaldehyde, acrolein, methanol, and propionaldehyde rely on factors derived specifically for Douglas fir. Since the CDK is a new technology in the Pacific Northwest, the direct-fired CDK emission factors are not available for drying Douglas fir. Emissions of these pollutants are assumed to result from two processes: combustion and drying. For combustion, VOC and HAP/TAP emissions are estimated based on "NCASI Technical Bulletin No. 1013: A Comprehensive Compilation and Review of Wood-Fired Boiler Emissions," Tables 4.1 and 5.1, which are displayed in Appendix E. For drying, VOC and the four HAP/TAP pollutants are estimated based on the Douglas fir indirect-heated batch dry kiln emission factors in EPA Region 10's guidance workbook, "EPA Region 10 HAP and VOC Emission Factors for Lumber Drying, January 2021," which depend on the maximum drying temperature of heated air entering the lumber (200 °F).

3.1.3 Fuel- and Species-Based Emissions

Formaldehyde is unique to all other HAP/TAP pollutants as it relies on both the wood species and the firing method. Due to formaldehyde's dependence on direct or indirect heating, the drying emission factor in the "EPA Region 10 HAP and VOC Emission Factors for Lumber Drying, January 2021" workbook may

underrepresent formaldehyde emissions. Therefore, this emission factor is scaled up by the proportion of direct to indirect mean batch kiln emission factors for formaldehyde in the "NCASI Wood Products Air Emission Factor Database – 2013 Update." Since this emission factor becomes a proxy for a direct-fired unit, the combustion emissions have been accounted for and therefore do not need to be added on top of the scaled emission factor, as was done for the other HAP/TAP pollutants. Further representation of this relationship is demonstrated in the detailed emission calculations in Appendix F.

3.2 Material Handling

As discussed in Section 2, the majority of material handling activities for the Project are controlled and are not expected to generate fugitive emissions, including covered conveyor transfers, enclosed drops, and blow pipe transfers. However, particulate emissions are generated from a few sources as part of this project, including cyclones and unenclosed drops. These emission-generating activities and calculation methods are summarized below.

3.2.1 Emissions Controlled by Cyclones and Baghouse

Since loading of the CDK fuel silo and bark and truck bins is controlled by cyclones, hourly filterable PM emissions are calculated using the manufacturer's specified exhaust flow rate and the grain loading posted in the 2021 ORCAA AEI workbook, which comes from FIRE 6.23 October 2000, SCC 30700804, 30700805, which is also in Table 10.4.1 AP-42, p. 10.4-2 (2/80). See the cyclone spec sheet in Appendix C for the fuel silo cyclone and Table 3.0 in the TSD for Permit 12AOP915 for the bark and dry chip cyclones. Based on the 2021 ORCAA AEI workbook, baghouses are assumed to maintain a control efficiency of 99%, so this factor is applied to the hourly emission rate from the dry chip cyclone. Annual emission rates are determined from the hourly emission rates and annual operating hours. The fuel silo, bark, and dry chip cyclones operate based on the sawmill operating hours, which are 100 hours per week for 52 weeks per year. According to the 2021 ORCAA AEI workbook, filterable PM₁₀ is assumed to be equal to 40% of filterable PM, and PM_{2.5} emissions are conservatively assumed to be equal to PM₁₀ emissions.

In the current Title V permit, cyclone emissions are categorized as "Wood Waste Collection", which will be updated to incorporate the aforementioned cyclones. Furthermore, the fuel silo cyclone is a new emission unit, and the bark cyclone was not previously included in the PTE (as shown in the 2021 AEI calculations), so both of these units will be added to this category as part of the Project. Additionally, since the dry chip cyclone will be relocated to a new process and controlled by a new baghouse, its emissions have been updated. Pre- and post-Project comparisons of dry chip cyclone and overall Wood Waste Collection emissions rates are provided in the detailed emission calculations in Appendix F.

3.2.2 Fugitive Emissions

Fugitive PM emissions are generated from the following material handling activities at the Facility:

- ▶ Green sawdust sawmill drop point
- ▶ Bark bins truck loadout
- ▶ Chip bins truck loadout

For each of these activities, fugitive PM emissions are quantified by using emission factors from AP-42 Section 13.2.4, Aggregate Handling and Storage Pile. Annual emissions for these sources are estimated from co-product throughputs, which are based on a ratio of CDK throughput. Hours of operations are then used to determine the hourly emission rates. Since the green sawdust drop point occurs inside the sawmill building, the minimum wind speed from the AP-42 section is used in the emission factor equation to

represent the building enclosure’s capture efficiency. As for the bark and chip bins, the units are fitted with steel sidings, so a capture efficiency of 50% is applied to the emission rates for truck loading.

As stated in Section 2.1.3, the green sawdust truck bin will occasionally be used to store surplus sawdust acquired during infrequent sawmill cleaning sessions, which will then be loaded onto trucks and sold. Due to the insignificant amount of sawdust transfer to the truck bin, the emissions from truck loadout are considered to be negligible. Further, the existing haul roads emissions calculation is conservative and has accounted for sawdust truck traffic, if any.

3.3 Haul Roads

Currently, ORCAA calculates the paved road emission in the annual emissions inventories using unpaved road emission factors and silt loading values from AP-42 Section 13.2.2, Unpaved Roads, while applying a 90% control efficiency for paving. Upon further review, Weyerhaeuser has determined that emission factor equations from AP-42 Section 13.2.1, Paved Roads, along with the average silt loading value for corn wet mills, more accurately represent the fugitive PM emissions from the paved haul roads. Furthermore, the silt loading for corn wet mills is used because the sawmill is expected to haul materials with a similar texture and moisture content. The Facility also waters the roads daily and sweeps the roads twice-monthly, further controlling fugitive emissions.

With updated routes for trucks and forklifts to accommodate for the CDK Project, the vehicle usage for haul road calculations has been modified. Appendix F details the updated haul road input information and displays the new emission rates for the Facility’s haul roads.

3.4 Project- and Facility-Wide Emissions

Table 3-1 and Table 3-2 display the Project potential-to-emit (PTE) summaries of criteria pollutant and HAP/TAP emissions for the proposed CDK and related changes at the Facility. Table 3-3 displays the post-Project Facility-wide PTE summary, along with the PSD New Source Review (NSR) pollutant thresholds. As shown in the table, the post-Project Facility-wide PTE is below PSD major source thresholds for all pollutants. Detailed potential emissions calculations are included as Appendix F of the permit application. The potential emissions calculations in Table 3-3 include point source emissions only and exclude fugitive emissions. The fugitive emissions are excluded because the sawmill operation is not on the PSD List of 28 categories with a lower major source threshold (100 tpy), which requires subject source categories to include fugitive emissions for permitting applicability determinations.

Table 3-1. Project Potential Emissions (tpy) — Criteria Pollutant Summary

Emission Unit	PM	PM₁₀	PM_{2.5}	SO₂	NO_x	VOC	CO	CO_{2e}
CDK	21.70	16.12	15.35	5.25	43.40	179.35	113.15	44,007
Chip and Bark Truck Bins	9.45	4.47	0.68	--	--	--	--	--
Fugitive Emissions - Green Sawdust	0.23	0.11	0.02	--	--	--	--	--
Haul Roads	0.90	0.18	0.04	--	--	--	--	--
Cyclones	9.92	3.97	3.97	--	--	--	--	--
Total:	42.20	24.84	20.05	5.25	43.40	179.35	113.15	44,007

Table 3-2. Project Potential Emissions — HAP/TAP Summary

Pollutant	CAS #	HAP?	TAP?	CDK Emissions		SQER ^a		Modeling Required?
				(lb/hr)	(tpy)	Averaging Period	(lb/Avg. period)	
Acetaldehyde	75-07-0	Yes	Yes	1.03	4.32	year	60	Yes
Acrolein	107-02-8	Yes	Yes	0.03	0.13	24-hr	0.026	Yes
Formaldehyde	50-00-0	Yes	Yes	0.32	1.34	year	27	Yes
Methanol	67-56-1	Yes	Yes	2.51	10.55	24-hr	1500	No
Propionaldehyde	123-38-6	Yes	Yes	0.02	0.10	24-hr	0.59	No
Carbon monoxide	630-08-0	No	Yes	26.94	113.15	1-hr	43	No
Nitrogen dioxide	10102-44-0	No	Yes	10.33	43.40	1-hr	0.87	Yes
Sulfur dioxide	7446-09-5	No	Yes	1.25	5.25	1-hr	1.2	Yes
Total HAP (tpy):					16.45			
Max Individual HAP (tpy):					10.55	Methanol		

a. The SQER for each TAP is obtained from the 2019 WAC 173-460 TAP list.

Table 3-3. Facility-Wide Potential Emissions (tpy) — Criteria Pollutant Summary

Emission Unit	Fugitive?	PM	PM₁₀	PM_{2.5}	SO₂	NO_x	VOC	CO	CO_{2e}
Wood Waste Collection - Cyclones	No	11.57	4.65	4.65	--	--	--	--	--
Fugitive Emissions - Roads	Yes	0.90	0.18	0.04	--	--	--	--	--
Log Debarking	Yes	6.5	3.6	0.5	--	--	--	--	--
CDK	No	21.70	16.12	15.35	5.25	43.40	179.35	113.15	44,007
Chip and Bark Truck Bins	Yes	9.45	4.47	0.68	--	--	--	--	--
Fugitive Emissions - Green Sawdust	Yes	0.23	0.11	0.02	--	--	--	--	--
Total Emissions (w/ fugitives):		50.34	29.12	21.23	5.25	43.40	179.35	113.15	44,007
Total Emissions (w/o fugitives):		33.27	20.77	19.99	5.25	43.40	179.35	113.15	44,007
PSD Major Source Thresholds:		250	250	250	250	250	250	250	100,000
PSD Threshold Exceeded ^a (Yes/No):		No	No	No	No	No	No	No	No

a. PSD is only applicable for GHG if the PSD threshold is exceeded for it and another pollutant.

4. REGULATORY APPLICABILITY

The following section outlines the applicability of various federal and state regulatory requirements.

4.1 NOC Permitting Applicability

Per ORCAA Rule 6.1(a), an NOC permit application must be filed, and a permit issued by ORCAA prior to the establishment of any new source or the modification of any existing stationary source. The proposed Project includes new emission sources. The emission units do not meet the categorical exemptions limited in ORCAA Rule 6.1(c). Therefore, an NOC is required per ORCAA Rule 6.1(a). Additionally, the proposed project is not categorically exempt from an NOC based on the source types listed in ORCAA Rule 6.1(c). This report serves as the required NOC application for the Project.

4.2 Best Available Control Technology (BACT)

Per ORCAA Rule 6.1.4(a)(2) and WAC 173-400-113(2), each new or modified stationary source must employ BACT for all pollutants not previously emitted, or any pollutants for which there is an emissions increase. WAC 173-460-040 requires that each source of TAPs with project emissions greater than the de minimis levels specified in WAC 173-460-150 employ BACT for toxics (tBACT). A detailed analysis of BACT and tBACT is provided in Section 5 of this report, and a summary of these findings is provided below in Table 4-1.

Table 4-1. BACT Summary

Emission Unit	Pollutant	BACT
CDK	VOC	Proper Maintenance and Operating Practices; Maximum Drying Temperature of 200 °F
	TAPs	
	PM	Proper Maintenance and Operating Practices
	CO	
	NO _x	Combustion Modifications; Proper Maintenance and Operating Practices
	SO ₂	Low Sulfur Fuels; Proper Maintenance and Operating Practices
Paved Roads	PM	Bi-Weekly Watering and Vacuuming
Material Transfer: Fuel Silo Loading; Bark Bin Loading	PM	Cyclone
Material Transfer: Chip Bin Loading (of Dry Chips)	PM	Cyclone and Baghouse
Material Transfer: Green Sawdust Sawmill Drop Point	PM	Building Enclosure
Material Transfer: Bark and Chip Bin Truck Loadout	PM	Steel Sidings

4.3 Prevention of Significant Deterioration (PSD)

Depending on the attainment status of the area, a project is subject to the PSD permitting program under WAC 173-400-700, or the Nonattainment New Source Review (NNSR) program under WAC 173-400-800, if the project is either a "major modification" to an existing "major source," or is a new major source itself. Because the Raymond site is in an attainment area for all criteria pollutants, NNSR does not apply.

Although the Facility is an existing major source under the State's PSD program, Weyerhaeuser has not triggered a PSD review to date. In the Facility's current operating permit, 12AOP915, The Department of Ecology determined that PSD review was not required for the Raymond Mill, so the Facility was not required to obtain a PSD permit. As shown in Table 3-3, the proposed Project will reduce the Facility-wide PTE for all NSR regulated pollutants to below the major source thresholds, so the Facility will no longer be a PSD major source post-Project. Therefore, the Project is not subject to PSD review or permitting.

4.4 Title V Operating Permit Program

40 CFR 70 establishes the federal Title V operating permit program. Washington State has incorporated the provisions of the federal program in WAC 173-401 Operating Permit Regulation. The major source thresholds with respect to the Washington Title V operating permit program for sources in attainment areas are 10 tpy for an individual HAP, 25 tpy for total HAP emissions, or 100 tpy for an individual criteria pollutant.

The Raymond Mill is currently a Title V major source of hazardous air pollutants, CO, NO_x, and VOC and is permitted under Permit Number 12AOP915 in ORCAA's jurisdiction. As identified previously in Table 3-3, the potential criteria pollutant emissions from point sources will continue to exceed 100 tpy for at least one criteria pollutant, so the Facility will remain a Title V major source and continue to comply with Title V permit requirements.

4.5 New Source Performance Standards (NSPS)

ORCAA has received delegation from EPA to regulate facilities subject to New Source Performance Standards (NSPS). Regulatory requirements for facilities subject to NSPS are incorporated by reference in ORCAA Rule 8.14 and located in 40 CFR Part 60. NSPS require new, modified, or reconstructed sources to control emissions to the level achievable by the best-demonstrated technology as specified in the applicable provisions. Moreover, any source subject to an NSPS is also subject to the general provisions of NSPS Subpart A, unless specifically excluded.

4.5.1 40 CFR 60 Subpart A – General Provisions

All affected sources are subject to the general provisions of NSPS Subpart A unless specifically excluded by the source-specific NSPS. Subpart A requires initial notification and performance testing, recordkeeping, monitoring, provides reference methods, and mandates general control device requirements for all other subparts as applicable.

4.5.2 40 CFR 60 Subparts D, Db, Dc – Standards of Performance for Steam Generating Units

NSPS Subpart D, Standards of Performance for Fossil Fuel-Fired Steam Generators for which Construction is Commenced after August 17, 1971, applies to steam generating units with a heat input capacity of 250 MMBtu/hr or greater from fossil fuel combustion for which construction is commenced after August 17,

1971. NSPS Subpart Db, Standards of Performance for Industrial-Commercial-Institutional Steam Generating Units, applies to industrial, commercial, and institutional steam generating units with a heat input greater than 100 MMBtu/hr that began construction, modification, or reconstruction after June 19, 1984. NSPS Subpart Dc, Standards of Performance for Small Industrial-Commercial-Institutional Steam Generating Units, applies to steam generating units with a maximum heat input capacity of 100 MMBtu/hr or less, but greater than or equal to 10 MMBtu/hr. The applicability date for Subpart Dc is June 9, 1989. The following definitions are important when assessing NSPS Subparts D, Db, and Dc applicability:²

1. A steam generating unit: "a device that combusts any fuel or byproduct/waste and produces steam or heats water or heats any heat transfer medium ..."
2. Heat transfer medium: "any material that is used to transfer heat from one point to another point."

The kiln will be directly fired by a 50 MMBtu/hr green sawdust gasifier to provide heat. The gasifier will be used to generate heat to dry green wood materials only, and no heat from the gasifier will be used to generate steam for other processes at the Facility. Additionally, the heat generated from the combustion gases will be in direct contact with the wood materials (i.e., there will not be a physical barrier between the combustion gases and the wood materials being dried). In a November 17, 1992 EPA Applicability Determination Index (ADI) Control Number PS36, titled "Process Dryers Applicability", EPA states the following:

*The key to distinguishing between a steam generating unit and a process dryer or kiln, however, is the method of heat transfer between the combustion gases and the heat transfer medium (if a heat transfer medium is involved). In a steam generating unit there is a physical barrier between the combustion gases and the heat transfer medium (e.g., the waterwall or tubes in the steam generating unit). ... Devices which either (1) combust fuel but do not transfer heat from the combustion gases to a heat transfer medium or (2) transfer heat to heat transfer medium by direct contact or intermixing of the combustion gases and the heat transfer medium are not considered steam generating units under Subparts Db and Dc. **Process dryers and kilns fall into this latter category and, as a result, Subparts Db and Dc do not apply to these types of combustion devices.***³

Accordingly, the gasifier in the CDK will not be subject to NSPS Subparts Db or Dc. Similarly, the gasifier will also not be subject to NSPS Subpart D.

4.5.3 40 CFR 60 Subpart CCCC – Standards of Performance for Commercial and Industrial Solid Waste Incineration Units

NSPS Subpart CCCC, Standards of Performance for Commercial and Industrial Solid Waste Incineration Units, applies to commercial and industrial solid waste incineration units (CISWIs) and air curtain incinerators (ACIs). As the proposed gasifier burners will combust green sawdust for fuel, the potential applicability of this regulation was reviewed.

40 CFR 241.2 (part of the solid waste regulations) defines a clean cellulosic biomass as

² 40 CFR 60.41c.

³ ADI Control Number PS36, Accessed July 15, 2022:
https://cfpub.epa.gov/adi/index.cfm?fuseaction=home.dsp_show_file_contents&CFID=27744188&CFTOKEN=bdc55e411167fe a2-202D6D9C-A359-4B37-4ACEC1D495F75EEA&id=PS36

...those residuals that are akin to traditional cellulosic biomass such as forest-derived biomass (e.g., green wood, forest thinnings, clean and unadulterated bark, sawdust, trim, and tree harvesting residuals from logging and sawmill materials), corn stover and other biomass crops used specifically for energy production (e.g., energy cane, other fast growing grasses), bagasse and other crop residues (e.g., peanut shells), wood collected from forest fire clearance activities, trees and clean wood found in disaster debris, clean biomass from land clearing operations, and clean construction and demolition wood. These fuels are not secondary materials or solid wastes unless discarded. Clean biomass is biomass that does not contain contaminants at concentrations not normally associated with virgin biomass materials.

The fuel for the gasifier burners will be green sawdust produced at the Raymond Mill. By the definition provided above, the green sawdust is not classified as secondary materials or solid waste in its proposed use at the Mill. As such, the combustion unit is not a CISWI unit, so the gasifier burner is not subject to Subpart CCCC.

4.6 National Emission Standards for Hazardous Air Pollutants (NESHAP)

National Emission Standards for Hazardous Air Pollutants (NESHAP) are emission standards for HAP and are applicable to major and area sources of HAP. A HAP major source is defined as a facility with potential emissions in excess of 25 tpy for total HAP or potential emissions in excess of 10 tpy for any individual HAP. An area source is a stationary source that is not a major source. As identified in Table 3-3, the Facility is a major source of HAP emissions, since the maximum individual HAP emissions are greater than 10 tpy.

Similar to NSPS, any source subject to a NESHAP is also subject to the general provision of NESHAP Subpart A, unless specifically excluded. Regulatory requirements for facilities subject to Part 61 and Part 63 NESHAP are incorporated by reference in ORCAA Rules 8.15 and 8.17, respectively.

4.6.1 40 CFR 63 Subpart A – General Provisions

All affected sources are subject to the general provisions of Part 63 NESHAP Subpart A unless specifically excluded by the source-specific NESHAP. Subpart A requires initial notification and performance testing, recordkeeping, monitoring, provides reference methods, and mandates general control device requirements for all other subparts as applicable.

4.6.2 40 CFR 63 Subpart DDDD – National Emission Standards for Hazardous Air Pollutants: Plywood and Composite Wood Products

NESHAP Subpart DDDD, NESHAP for Plywood and Composite Wood Products, applies to major sources of HAP that manufacture plywood or composite wood products by bonding wood materials (fibers, particles, strands, veneers, etc.) or agricultural fiber, generally with resin under heat and pressure, to form a structural panel or engineered wood product. Lumber kilns are process units within the existing “affected source” under this subpart MACT, defined in 40 CFR 63.2232(b) as

The collection of dryers, refiners, blenders, formers, presses, board coolers, and other process units associated with the manufacturing of plywood and composite wood products. The affected source includes, but is not limited to, green end operations, refining, drying operations (including any combustion unit exhaust stream routinely used to direct fire process unit(s)), resin preparation, blending and

forming operations, pressing and board cooling operations, and miscellaneous finishing operations (such as sanding, sawing, patching, edge sealing, and other finishing operations not subject to other national emission standards for hazardous air pollutants (NESHAP)). The affected source also includes onsite storage and preparation of raw materials used in the manufacture of plywood and/or composite wood products, such as resins; onsite wastewater treatment operations specifically associated with plywood and composite wood products manufacturing; and miscellaneous coating operations (§63.2292). The affected source includes lumber kilns at PCWP manufacturing facilities and at any other kind of facility.

However, based on §63.2252, for process units not subject to the compliance options or work practice requirements specified in §63.2240 (including, but not limited to, lumber kilns), the Facility is not required to comply with the compliance options; work practice requirements; performance testing; monitoring; startup, shutdown, and malfunction (SSM) plans; and recordkeeping or reporting requirements of Subpart DDDD, or any other requirements in NESHAP Subpart A, General Provisions, except for the initial notification requirements in §63.9(b). According to §63.9(b)(iii), this NOC application will serve as the initial notification for the CDK. Although the lumber kilns are an affected source, there are no applicable requirements for the proposed direct-fired CDK at the Facility. The Raymond Mill is already subject to Subpart DDDD for the batch lumber kilns and have demonstrated compliance, so the Facility will continue to comply with 40 CFR 63 Subpart DDDD for the CDK.

4.6.3 40 CFR 63 Subpart DDDDD – National Emission Standards for Hazardous Air Pollutants for Major Sources: Industrial, Commercial, and Institutional Boilers and Process Heaters

The revised NESHAP Subpart DDDDD, NESHAP for Industrial, Commercial, and Institutional Boilers and Process Heaters (commonly referred to as the Boiler MACT), regulates HAP emissions from solid, liquid, and gaseous-fired boilers and steam generating units at major sources of HAP emissions. Under the most recent version of the Boiler MACT, a process heater is defined in 40 CFR 63.7575, as

...an enclosed device using controlled flame, and the unit's primary purpose is to transfer heat indirectly to a process material (liquid, gas, or solid) or to a heat transfer material (e.g., glycol or a mixture of glycol and water) for use in a process unit, instead of generating steam. Process heaters are devices in which the combustion gases do not come into direct contact with process materials. A device combusting solid waste, as defined in § 241.3 of this chapter, is not a process heater unless the device is exempt from the definition of a solid waste incineration unit as provided in section 129(g)(1) of the Clean Air Act. Process heaters do not include units used for comfort heat or space heat, food preparation for on-site consumption, or autoclaves.

The continuous lumber kiln will be direct-fired, as the combustion gases from the fuel will directly contact the lumber during the drying process. Therefore, the new lumber kiln is not considered a process heater, and therefore is not subject to the Boiler MACT.

4.6.4 40 CFR 63 Subpart JJJJJJ – National Emission Standards for Hazardous Air Pollutants for Industrial, Commercial, and Institutional Boilers Area Sources

NESHAP Subpart JJJJJJ, NESHAP for Area Sources: Industrial, Commercial, and Institutional Boilers, regulates HAP emissions from boilers and steam generating units at facilities that are area sources of HAP emissions. The Facility is a major source of HAP emissions; and there are no proposed boilers or process heaters; therefore, the Facility is not subject to Subpart JJJJJJ.

4.7 State Regulatory Applicability

4.7.1 Washington Toxic Air Pollutant Regulations

In Washington, all new sources emitting TAPs are required to show compliance with the Washington TAP program pursuant to WAC 173-460. ORCAA incorporates the Washington TAP program by reference. WAC 173-460 established a De Minimis, Small Quantity Emission Rate (SQER) and an Acceptable Source Impact Level (ASIL) for each listed TAP. An *acceptable source impact analysis* must be conducted for each TAP with an emission increase. The toxics rule, in WAC 173-460-080(2) allows for applicants to satisfy the acceptable source impact limit if emissions are below the SQER for each TAP. As shown in Table 3-2, several pollutants are above their respective SQERs; therefore, dispersion modeling is required. The acceptable source impact analysis and dispersion modeling are presented in Sections 6 and 7 of this report.

4.7.2 General Emissions Standards and Practices

WAC 173-400 contains emission standards that are applicable unless a more stringent standard applies. A complete list of the standards and practices applicable to the Project is presented in Table 4-2.

Table 4-2. Emission Standards for Affected Sources

Pollutant	Emission Limits	Emission Unit Subject to Emission Limit
PM	WAC 173-400-060, ORCAA Rule 8.3: 0.23 grams per dry cubic meter particulate at standard conditions (0.1 gr/dscf) from exhaust gas. WAC 173-400-040(3), ORCAA Rule 8.3: "No person shall cause or allow the emission of particulate matter from any source to be deposited beyond the property under direct control of the owner or operator of the source in sufficient quantity to interfere unreasonably with the use and enjoyment of the property upon which the material is deposited."	All Emission Units
SO ₂	WAC 173-400-040(7): 1,000 ppm on dry weight, 7% O ₂ or 12% CO ₂ basis, averaged over a consecutive 60-minute period.	CDK
Opacity	WAC 173-400-040(2), ORCAA Rule 8.2: 20% for no more than 3 minutes in a 1-hour period.	All Emission Units
Detriment to Person or Property	WAC 173-400-040(6), ORCAA Rule 7.6: "No person shall cause or allow the emission of any air contaminant from any source if it is detrimental to the health, safety, or welfare of any person, or causes damage to property or business."	All Emission Units

Pollutant	Emission Limits	Emission Unit Subject to Emission Limit
Odor	WAC 173-400-040(5), ORCAA Rule 8.5: Weyerhaeuser will not allow the generation of any odor from any source or activity which may unreasonably interfere with any other property owner's use and enjoyment of her or his property. Weyerhaeuser must use recognized good practice and procedures to reduce these odors to a reasonable minimum.	All Emission Units
Emission Concealment	WAC 173-400-040(8), ORCAA Rule 7.5: Weyerhaeuser shall not conceal emissions that would otherwise violate ORCAA regulation emission standards or provisions of WAC 173-400, or cause detriment to health, safety, or welfare of any person, or cause damage to property or business.	All Emission Units
Fugitive Emissions	WAC 173-400-040(4): Weyerhaeuser shall take reasonable precautions to prevent the release of air contaminants from the operation of any "emission unit" that emits fugitive emissions.	Chip and Bark Truck Bins, Green Sawdust Sawmill Drop, Haul Roads
Fugitive Dust	WAC 173-400-040(9), ORCAA Rule 8.3: Weyerhaeuser shall take reasonable precautions to prevent fugitive dust from becoming airborne from any source that emits fugitive dust, as well as maintain minimal emissions.	Chip and Bark Truck Bins, Green Sawdust Sawmill Drop, Haul Roads
Hazardous Air Pollutants	WAC 173-400-075: See adopted standards in Section 4.6 (National Emission Standards for Hazardous Air Pollutants).	All Emission Units emitting HAPs
Toxic Air Pollutants	WAC 173-400-076, ORCAA Rule 8.6: See adopted standards in Section 4.7.1 (Washington Toxic Air Pollutant Regulations).	All Emission Units emitting TAPs
Vertical Stack Dispersion, Creditable Stack Height, and Dispersion Techniques	WAC 173-400-200(2): Weyerhaeuser shall not use dispersion techniques or excess stack height to meet air quality standards. Excess stack height quantifies as the portion of a stack that exceeds the greater of 65 meters, or the GEP stack height.	All Emission Units
Excess Emissions	ORCAA Rule 8.7: An excess emission is defined in Rule 1.4 as emissions of an air pollutant in excess of an applicable emission standard. Weyerhaeuser is required to report any excess emissions to ORCAA as soon as possible and within the timeliness and report completeness requirements outlined in Rule 8.7(a) and (b).	All Emission Units
Control Equipment – Maintenance and Repair	ORCAA Rule 8.8: Weyerhaeuser is required to keep any process and/or air pollution control equipment in good operating condition and repair.	All Emission Units

4.8 Local Regulatory Applicability

4.8.1 General Emissions Standards and Practices

ORCAA regulations contain emission standards that apply to the Facility. These standards are summarized in Table 4-2 of this application.

4.8.2 ORCAA Rule 8.1 – Wood Heating

ORCAA Rule 8.1 determines performance standards for solid fuel burning devices. Per ORCAA Rule 8.1.1, a “solid fuel burning device” is defined as “a device that burns seasoned wood, coal, or any other nongaseous or nonliquid fuels except those prohibited by Rule 8.1.3.” The Rule also defines “seasoned wood” as “clean, untreated wood of any species that has been dried and contains twenty percent (20%), or less, moisture by weight.” The CDK burner will fire green sawdust with a moisture greater than this value, so the Project is not subject to this Rule.

5. BEST AVAILABLE CONTROL TECHNOLOGY

Pursuant to ORCAA Rule 6.1.4(a)(2) and WAC 173-400-113, all new and modified sources must employ BACT for "all pollutants not previously emitted or whose emissions would increase as a result of the new source or modification." This section includes a BACT analysis for the CDK, haul roads, and material handling. The BACT analyses for PM, _{so2}, NO_x, VOC, and CO, as well as tBACT for TAPs for these emission units are presented in the subsequent sections.

5.1 BACT Methodology

In a memorandum dated December 1, 1987, EPA stated its preference for a "top-down" BACT analysis.⁴ After determining if any NSPS or NESHAP is applicable, the first step in this approach is to determine, for the emission unit in question, the most stringent control available for a similar or identical source or source category. If it can be shown that this level of control is technically, environmentally, or economically infeasible for the unit in question, then the next most stringent level of control is determined and similarly evaluated. This process continues until the BACT level under consideration cannot be eliminated by any substantial or unique technical, environmental, or economic objections. The five basic steps of a top-down BACT review as identified by the EPA are presented below.⁵

5.1.1 Step 1 – Identify All Control Technologies

Available control technologies are identified for each emission unit in question. The following methods are used to identify potential technologies: (1) reviewing entries in the Reasonably Available Control Technology (RACT)/BACT/Lowest Achievable Emission Rate (LAER) Clearinghouse (RBLC) database, (2) surveying regulatory agencies, (3) drawing from similar experience in assessing emissions control strategies, (4) surveying air pollution control equipment vendors, and/or (5) researching available literature.

5.1.2 Step 2 – Eliminate Technically Infeasible Options

After the identification of control options, an analysis is conducted to eliminate technically infeasible options. A control option is eliminated from consideration if there are process specific conditions that prohibit the implementation of the control technology or if the highest control efficiency of the option would result in an emission level that is higher than any applicable regulatory limits, such as an NSPS or NESHAP.

5.1.3 Step 3 – Rank Remaining Control Technologies by Control Effectiveness

Once technically infeasible options are removed from consideration, the remaining options are ranked based on their control effectiveness. If there is only one remaining option or if all of the remaining technologies could achieve equivalent control efficiencies, ranking based on control efficiency is not required.

5.1.4 Step 4 – Evaluate Most Effective Controls and Document Results

Beginning with the most efficient control option in the ranking, detailed economic, energy, and environmental impact evaluations are performed. If a control option is determined to be economically

⁴ U.S. EPA, Office of Air and Radiation. Memorandum from J.C. Potter to the Regional Administrators. Washington, D.C. December 1, 1987.

⁵ U.S. EPA. *Draft New Source Review Workshop Manual*, Chapter B. Research Triangle Park, North Carolina. October, 1990.

feasible without adverse energy or environmental impacts, it is not necessary to evaluate the remaining options with lower control efficiencies.

The economic evaluation centers on the cost effectiveness of the control option. Costs of installing and operating control technologies are estimated and annualized following the methodologies outlined in the EPA's OAQPS Control Cost Manual (CCM) and other industry resources.⁶

5.1.5 Step 5 – Select BACT

In the final step, one pollutant-specific control option and/or limit is proposed as BACT for each emission unit under review based on evaluations from the previous step.

Comprehensive “top-down” review is not always necessary for BACT analyses. At a minimum, a complete BACT determination must assess the technical, environmental, and economic feasibility of the most stringent controls available. The BACT analyses in this application follow the framework of the “top-down” approach.

The BACT analyses for the new emission units are presented in the following sections.

5.2 BACT Analysis for New CDK

5.2.1 BACT Analysis for VOC Emissions

VOC is emitted when the carbonaceous matter in the fuel is not converted to CO₂ or CO. Based on the RBLC database results in Table 5-1, as well as existing air permits and applications for direct-fired CDKs, including the West Fraser Augusta Mill's Title V Application No. 21615 approved by the Georgia Environmental Protection Division (EPD), the following control methods were identified for initial review:^{7,8}

- ▶ Included in RBLC
 - Proper Maintenance and Operating Practices
- ▶ Other Controls
 - Adsorption
 - Biofiltration
 - Condensation
 - Thermal Oxidation
 - Wet Scrubber

⁶ Office of Air Quality Planning and Standards (OAQPS), *EPA Air Pollution Control Cost Manual*, Sixth Edition, EPA 452-02-001 (<http://www.epa.gov/ttn/catc/products.html#ccinfo>), Daniel C. Mussatti & William M. Vatauvuk, January 2002.

⁷ RBLC search conducted on July 3, 2023 for direct-fired continuous dry kilns under process code 30.800 with a permit date between 1/1/2013 and 7/3/2023.

⁸ West Fraser – Augusta Mill, *Continuous Kilns Construction Permit Application*, Trinity Consultants, December 2012. (<https://epd.georgia.gov/document/document/2450047psdapppdf/download>)

Table 5-1. RBLC Results for VOC Emissions from CDKs

Facility Name	State	Permit #	Process Name	Control Method	Emission Limit 1	Unit 1	Emission Limit 2	Unit 2
West Fraser-Opelika Lumber Mill	AL	206-5004-X005	Two 87.5 MMBF/yr CDKs with a 35 MMBtu/hr direct-fired wood burner	--	3.76	lb/MBF	175	K/12 months
West Fraser, Inc. – Maplesville Mill	AL	403-5005-X010	Two 100 MMBF/yr Direct-Fired CDK	--	3.76	lb/MBF	--	--
Millport Wood Products Facility	AL	408-5003-X022	Direct-Fired CDK	Proper Maintenance and Operating Practices	4.7	lb/MBF as WWP1 VOC	--	--
Resolute Forest Products – Alabama Sawmill	AL	309-0072-X002	Direct-Fired CDKs with 35 MMBtu/hr Wood-Fired Burner	--	3.76 ^a	lb/MBF	--	--
Two Rivers Lumber Co.	AL	105-S007-X002	15.4 MBF/hr CDK (DPK-1) w/ 38.8 MMBtu/hr NG Burner	--	3.8	lb/MBF as C	--	--
			15.4 MBF/hr CDK (DPK-2) w/ 38.8 MMBtu/hr NG Burner	--	3.8	lb/MBF as C	--	--
Fulton Sawmill	AL	X007 & X008	11.4 MBF/hr Direct-Fired CDK, 40 MMBtu/hr NG Burner, & 4 MMBtu/hr NG Condensate Evaporator	Proper Kiln Operation and Maintenance Practices	4	lb/MBF	--	--
Millport Wood Products Facility	AL	X023	Three Direct-Fired CDKs Dry Kilns, CDK-4/X023A, CDK-5/X023B, CDK-6/X023C	Operating And Maintenance Practices	4.7	lb/MBF as WWP1 VOC	--	--
Belk Chip-N-Saw Facility	AL	X006, X008, X009	115,000 MBF/yr CDK D (ES-006) with 35 MMBtu/hr Wood-Fired and 7 MMBtu/hr NG-Fired Burners	Operating And Maintenance Practices; Measure Lumber Moisture Content	5.49	lb/MBF as WWP1 VOC	--	--
			115,000 MBF/yr CDK E (ES-009) with 35 MMBtu/hr Wood-Fired and 7 MMBtu/hr NG-Fired Burners		5.49	lb/MBF as WWP1 VOC	--	--
Cottonton Sawmill	AL	211-S005-X007	Direct-fired CDK with 34 MMBtu/hr Wood-Fired Burner	Good Combustion Practices and Proper Maintenance	4.21	lb/MBF as Terpenes	--	--
OLA	AR	0592-AOP-R10	Drying Kiln No. 5 (SN-21)	--	23.5 ^b	lb/hr	3.5 ^b	lb/MBF
Georgia-Pacific Wood Products South	AR	463-AOP-R8	SN-09 #4 Lumber Kiln	--	3.8	lb/MBF	373.7	tpy

Facility Name	State	Permit #	Process Name	Control Method	Emission Limit 1	Unit 1	Emission Limit 2	Unit 2
El Dorado Sawmill	AR	2348-AOP-R0	LUMBER DRYING KILN SN-01	Proper Maintenance and Operation	3.8	lb/MBF	--	--
			LUMBER DRYING KILN SN-02	--	3.8	lb/MBF	--	--
			LUMBER DRYING KILN SN-03	--	3.8	lb/MBF	--	--
Deltic Timber Corporation – OLA	AR	0592-AOP-R10	Direct-Fired CDK NO. 5	Proper Drying Schedule, Temperature-Based on Moisture Content, and Manufacturer's Specs	38.2 ^c	lb/hr	--	--
Caddo River	AR	0189-AOP-R6	CDKs	--	53.2	lb/hr	220.4 ^a	tpy
West Fraser, Inc.	AR	1628-AOP-R11	N/A	--	3.8	lb/MMBF	63.6	lb/hr
Anthony Forest Products Company	AR	1681-AOP-R15	Dual Path Kiln #3	--	3.8	lb/MBF	--	--
Caddo River	AR	0189-AOP-R8	Dual Path Kiln # 3	--	3.8	lb/MBF	53.2	lb/hr
Interfor U.S. Inc	AR	1567-AOP-R7	CDK #2 to continuous operation	--	3.8	lb/MBF	--	--
Anthony Timberlands	AR	0456-AOP-R9	CDK	--	36.8	lb/hr	350	tpy
Georgia-Pacific Wood Products South	AR	0463-AOP-R21	SN-09 #4 Lumber Kiln	--	3.8	lb/MBF	460.9	tpy
Anthony Forest Products Company	AR	1681-AOP-R20	Dual Path Kiln #4	--	62	lb/hr	228	tpy
Perry Mill	FL	1230033-012-AC	Direct-fired lumber drying kiln	Best Operating Practices (BMP)	3.5	lb/MBF	--	--
Whitehouse Lumber Mill	FL	0310197-012-AC	Direct-Fired CDKs	Proper Maintenance and Operating Procedures	3.76	lb/MBF	--	--
Graceville Lumber Mill	FL	0630011-016-AC	Direct-fired continuous lumber drying Kiln No. 5	Lumber moisture used as proxy for VOC emissions – product that is over dried likely means more VOC driven off and emitted	3.5	lb/MBF	--	--
Southwest Louisiana Lumber Operations	LA	PSD-LA-770	EP-3K -Wood-Fired Dry Kiln No. 1	Proper kiln design & operation; annual production limit	29.27	lb/hr	2.96	lb/MBF
			EP-4K -Wood-Fired Dry Kiln No. 2		29.27	lb/hr	2.96	lb/MBF
			EP-5K -Wood-Fired Dry Kiln No. 3		29.27	lb/hr	2.96	lb/MBF
			EP-6K -Wood-Fired Dry Kiln No. 4		29.27	lb/hr	2.96	lb/MBF

Facility Name	State	Permit #	Process Name	Control Method	Emission Limit 1	Unit 1	Emission Limit 2	Unit 2
Chopin Mill	LA	PSD-LA-784	Lumber Dry Kilns #1&2 (EQT 37&38)	Good operating practices	24.51	lb/hr	53.68	tpy
Joyce Mill	LA	PSD-LA-701(M-2)	GRP0003 Lumber Lilns (AK1)	Properly design and operation	4.2	lb/MBF	300	MMBF/yr
Bogalusa Sawmill	LA	PSD-LA-831	Lumber Kilns (2)	Proper operation and maintenance	--	--	--	--
Holden Wood Products Mill	LA	PSD-LA-834	CDKs A and B (01-19 and 02-19)	Proper Kiln Design and Good Operating Practices	4.33	lb/MBF	--	--
Idabel Sawmill	OK	2015-1163-C(M-1)PSD	Lumber Kiln	--	3.88	lb/MBF	--	--
West Fraser – Newberry Lumber Mill	SC	1780-0007-CG	Two – 35 MMBtu/hr Dual Path, Direct-Fired, CDKs, 15 MBF/hr, Each	Proper Operation and Good Operating Practices	3.76	lb/MBF	376	tpy
New South Lumber Co – Darlington Plant	SC	0820-0045-CJ	DKN5	Proper Maintenance and Operation	141	tpy	--	--
Kapstone Charleston Kraft – Summerville	SC	0900-0017-CE	Lumber Kilns	Proper Maintenance and Operation	225.6	tpy	3.76	lb/MBF
Simpson Lumber Co	SC	1140-0008-CH	Lumber Kilns	Proper Operation and Maintenance	156	tpy	3.76	lb/MBF
New South Companies, Inc. – Conway Plant	SC	1340-0029-CH-R2	Lumber Kilns	Proper Maintenance and Operation	602	tpy	4.2	lb/MBF
New South Lumber Company – Darlington	SC	0820-0045-CK	Two Kilns – KLN5 And KLN6	Proper Operation and Maintenance	--	--	--	--
Camden Plant	SC	1380-0025-CJ	DKN6 – Direct-Fired CDK	--	150.4	tpy	--	--
Georgia Pacific – McCormick Sawmill	SC	1600-0002-CD	Direct-Fired CDK	Good work practices	5.84	lb/MBF as Propane + Methanol + Formaldehyde	--	--
Resolute FP – Catawba Lumber Mill	SC	2440-0216-CA	3 Direct-Fired CDKs (CDK1, CDK2, CDK3)	--	5.82	lb/MBF as Terpene + Methanol + Formaldehyde	--	--
NSLC – Darlington	SC	0820-0045-CL	Lumber Drying Kiln 7	Work practice standards	4.2	lb/MBF as Terpene + Methanol + Formaldehyde	--	--
Canfor Southern Pine – Camden Plant	SC	1380-0025-CL	Lumber Drying Kiln 7	Work practice standards	5.82	lb/MBF	--	--

Facility Name	State	Permit #	Process Name	Control Method	Emission Limit 1	Unit 1	Emission Limit 2	Unit 2
						as Terpene + Methanol + Formaldehyde		
Charles Ingram Lumber Company, Inc	SC	1040-0016-CG	Kiln K3	Work Practice Standards	5.824	lb/MBF as Terpene + Methanol + Formaldehyde	--	--
			Kiln K7		5.824	lb/MBF as Terpene + Methanol + Formaldehyde	--	--
Lumber Mill	TX	6729,PSD TX15 2 AND GHGPSD TX1	Kilns (EPNs CK01 and CK02)	Proper design and operation	3.38	lb/DBF	--	--
Lumber Mill	TX	7286 AND PSD TX892M2	Direct-Fired Wood Drying Kiln No. 3	Proper operation and maintenance of the kiln	4.24	lb/MBF	--	--

- a. Rolling 12-months.
- b. Average of three 1-hr test runs.
- c. Averaged over drying cycle time.

Upon further analysis, all add-on control technologies were deemed to be technically infeasible. As the only technically feasible control method, Weyerhaeuser proposes proper maintenance and operating practices as BACT for VOC emissions from the CDK. In the TSD for the Facility's current TV permit, ORCAA determined BACT for lumber drying operations to be implementation of a steam management system. Since the CDK will be direct-fired, steam is not a practical variable to include. Therefore, Weyerhaeuser will incorporate this requirement by installing a kiln management system and in-kiln moisture management system, both of which provide for optimal drying efficiency and operating practices. Additionally, temperature has a significant impact on drying-based emissions, so Weyerhaeuser will operate the CDK with a maximum drying temperature of 200 °F to limit VOC emissions.

While there are various emission limits presented in the RBLC search results, they are all sourced from facilities in the Southeastern United States (US), which do not process Douglas fir. Since VOC emissions are dependent on wood species, Weyerhaeuser does not deem the RBLC emission limits to be representative of the Raymond Facility's CDK operation, so instead, the Facility proposes a new VOC BACT emission limit that uses the methodology discussed in Section 3.1.2. This limit includes two components: 1.149 lb/MBF for drying-based emissions and 6.19×10^{-3} lb/MMBtu for combustion-based emissions.

5.2.2 BACT Analysis for PM Emissions

PM emissions consist of filterable and condensable particulate matter produced by the combustion of wood fuel. Based on the RBLC database results in Table 5-2, as well as existing air permits and applications for direct-fired CDKs, the following control methods were identified for initial review:⁹

- ▶ Included in RBLC
 - Proper Maintenance and Operating Practices
- ▶ Other Controls
 - Baghouse
 - Cyclone
 - Scrubber
 - Dry Electrostatic Precipitator (Dry ESP)
 - Wet Electrostatic Precipitator (WESP)

⁹ RBLC search conducted on July 3, 2023 for direct-fired continuous dry kilns under process code 30.800 with a permit date between 1/1/2013 and 7/3/2023.

Table 5-2. RBLC Results for PM Emissions from CDKs

Facility Name	Permit #	Process Name	Control Method	Pollutant	Emission Limit 1	Unit 1	Emission Limit 2	Unit 2
Two Rivers Lumber Co.	105-S007-X002	15.4 MBF/hr CDK (DPK-1) w/ 38.8 MMBtu/hr Natural Gas Burner	--	Total PM (TPM)	1.3	lb/hr	--	--
		15.4 MBF/hr CDK (DPK-2) w/ 38.8 MMBtu/hr Natural Gas Burner			1.3	lb/hr	--	--
Fulton Sawmill	X007 & X008	11.4 MBF/hr Direct-Fired CDK, 40 MMBtu/hr Natural Gas Burner, & 4 MMBtu/hr Natural Gas Condensate Evaporator	--	TPM	--	--	--	--
Anthony Forest Products Company	1681-AOP-R20	Dual Path Kiln #4	--	TPM	2.4	lb/hr	8.6	tpy
				TPM ₁₀	2.3	lb/hr	8.5	tpy
		Dual Path Kiln #4 Abort Stack		TPM	3.1	lb/hr	0.5	tpy
				TPM ₁₀	2.8	lb/hr	0.4	tpy
Resolute FP – Catawba Lumber Mill	2440-0216-CA	3 Direct-Fired CDKs (CDK1, CDK2, CDK3)	--	TPM	0.14 ^a	lb/MBF	--	--
				TPM ₁₀	0.104 ^a	lb/MBF	--	--
				TPM _{2.5}	0.099 ^a	lb/MBF	--	--

a. Emission limits are for each kiln, on a 3-hour average.

Upon further analysis, all add-on control technologies were deemed to be technically infeasible. As the only technically feasible control method, Weyerhaeuser proposes proper maintenance and operating practices as BACT for PM emissions from the CDK. Following guidance from the RBLC search and Georgia EPD, Weyerhaeuser proposes the following PM BACT emission limits:¹⁰

- ▶ Total PM: 0.140 lb/MBF
- ▶ Total PM₁₀: 0.104 lb/MBF
- ▶ Total PM_{2.5}: 0.099 lb/MBF

5.2.3 BACT Analysis for CO Emissions

CO emissions result primarily from the incomplete combustion of biomass. Based on the RBLC database results in Table 5-3, as well as existing air permits and applications for direct-fired CDKs, the following control methods were identified for initial review:¹¹

- ▶ Included in RBLC
 - Proper Maintenance and Operating Practices
- ▶ Other Controls
 - Thermal Oxidation
 - Catalytic Oxidation

Table 5-3. RBLC Results for CO Emissions from CDKs

Facility Name	Permit #	Process Name	Control Method	Emission Limit 1	Unit 1	Emission Limit 2	Unit 2
Resolute Forest Products – Alabama Sawmill	309-0072-X002	Direct-Fired CDKs with 35 MMBtu/hr Wood-Fired Burner	Proper Maintenance and Operating Procedures	0.73 ^a	lb/MBF	--	--
Fulton Sawmill	X007 & X008	11.4 MBF/hr Direct-Fired CDK, 40 MMBtu/hr Natural Gas Burner, & 4 MMBtu/hr Natural Gas Condensate Evaporator	--	--	--	--	--
Anthony Forest Products Company	1681-AOP-R20	Dual Path Kiln #4	--	20.4	lb/hr	89.4	tpy
Resolute FP – Catawba Lumber Mill	2440-0216-CA	3 Direct-Fired CDKs (CDK1, CDK2, CDK3)	--	0.73 ^b	lb/MBF	--	--

- a. Rolling 12-months.
- b. 3-hour average.

¹⁰ Georgia Environmental Protection Division’s (EPD) document entitled “EPD Recommended Emission Factors for Lumber Kiln Permitting in Georgia”.

¹¹ RBLC search conducted on July 3, 2023 for direct-fired continuous dry kilns under process code 30.800 with a permit date between 1/1/2013 and 7/3/2023.

Upon further analysis, all add-on control technologies were deemed to be technically infeasible. As the only technically feasible control method, Weyerhaeuser proposes proper maintenance and operating practices as BACT for CO emissions from the CDK. Following guidance from the RBLC search and Georgia EPD, Weyerhaeuser proposes 0.73 lb/MBF as the CO BACT emission limit.¹²

5.2.4 BACT Analysis for NO_x Emissions

NO_x emissions result primarily from thermal NO_x formation from nitrogen and oxygen in the combustion air. Based on the RBLC database results in Table 5-4, as well as existing air permits and applications in the wood products industry, the following control methods were identified for initial review:¹³

- ▶ Included in RBLC
 - N/A
- ▶ Other Controls
 - Combustion Modifications
 - Selective Catalytic Reduction (SCR)
 - Selective Non-Catalytic Reduction (SNCR)
 - Water/Steam Injection
 - Proper Maintenance and Operating Practices

Table 5-4. RBLC Results for NO_x Emissions from CDKs

Facility Name	Permit #	Process Name	Control Method	Emission Limit 1	Unit 1	Emission Limit 2	Unit 2
Fulton Sawmill	X007 & X008	11.4 MBF/hr Direct-Fired CDK, 40 MMBtu/hr Natural Gas Burner, & 4 MMBtu/hr Natural Gas Condensate Evaporator	--	--	--	--	--
Anthony Forest Products Company	1681-AOP-R20	Dual Path Kiln #4	--	4.6	lb/hr	16.8	tpy

5.2.4.1 Technical Review

Optimal temperature ranges for SCR and SNCR applications are 480°F to 800°F and 1,600°F to 2,100°F, respectively.^{14,15} Since the gasifier typically runs at approximately 1,400°F and the secondary burner runs at

¹² Georgia Environmental Protection Division’s (EPD) document entitled “EPD Recommended Emission Factors for Lumber Kiln Permitting in Georgia”.

¹³ RBLC search conducted on July 3, 2023 for direct-fired continuous dry kilns under process code 30.800 with a permit date between 1/1/2013 and 7/3/2023.

¹⁴ EPA, *Air Pollution Control Technology Fact Sheet, Selective Catalytic Reduction (SCR)*, EPA-452/F-03-015. (<https://www3.epa.gov/ttnecat1/dir1/fscr.pdf>).

¹⁵ EPA, *Air Pollution Control Technology Fact Sheet, Selective Non-Catalytic Reduction (SNCR)*, EPA-452/F-03-031. (<https://www3.epa.gov/ttnecat1/dir1/fsnrcr.pdf>).

around 1,850°F, an SCR is technically infeasible.¹⁶ Additionally, an SNCR typically controls systems with uncontrolled NO_x levels between 200 and 400 ppm.¹⁷ With a combined exhaust flow rate of 50,000 cfm, a vendor-specified exhaust density of 0.0663 lb/ft³, and hourly NO_x emission rate of 10.33 lb/hr, the concentration of NO_x in the CDK exhaust is approximated to be 52 ppm. Therefore, an SNCR is also technically infeasible for the CDK.

Water/steam injection is not a demonstrated NO_x control method for direct-fired kilns in the wood products industry, so it is technically infeasible.

Combustion modifications, such as staged-air combustion, low NO_x burners (LNB), and flue gas recirculation (FGR), are technically feasible and typically have a control efficiency range between 10-50%.

5.2.4.2 BACT Determination

Per the vendor's guarantee, the green sawdust gasification burners will be designed with a "secondary gas burner system with [three] individual burner chambers," as well as flue gas recirculation, so Weyerhaeuser proposes combustion modifications and proper maintenance and operating practices as BACT for NO_x emissions from the CDK. Following guidance from Georgia EPD, Weyerhaeuser proposes 0.28 lb/MBF as the NO_x BACT emission limit.¹⁸

5.2.5 BACT Analysis for SO₂ Emissions

Based on the RBLC database results in Table 5-5, as well as existing air permits and applications in the wood products industry, the following control methods were identified for initial review:¹⁹

- ▶ Included in RBLC
 - N/A
- ▶ Other Controls
 - Fuel Gas Desulfurization (FGD)
 - Acid Gas Scrubber
 - Alternative Fuels
 - Proper Maintenance and Operating Practices

¹⁶ Girardi, R. and Womac, C. *DIRECT-FIRED GREEN SAWDUST GASIFICATION DRY KILN*, Western Dry Kiln Association. April, 2007. (<https://ir.library.oregonstate.edu/downloads/ng451j669>).

¹⁷ EPA, *Air Pollution Control Technology Fact Sheet, Selective Non-Catalytic Reduction (SNCR)*, EPA-452/F-03-031. (<https://www3.epa.gov/ttnatc1/dir1/fsncr.pdf>).

¹⁸ Georgia Environmental Protection Division's (EPD) document entitled "EPD Recommended Emission Factors for Lumber Kiln Permitting in Georgia".

¹⁹ RBLC search conducted on July 3, 2023 for direct-fired continuous dry kilns under process code 30.800 with a permit date between 1/1/2013 and 7/3/2023.

Table 5-5. RBLC Results for _{SO2} Emissions from CDKs

Facility Name	Permit #	Process Name	Control Method	Emission Limit 1	Unit 1	Emission Limit 2	Unit 2
Fulton Sawmill	X007 & X008	11.4 MBF/hr Direct-Fired CDK, 40 MMBtu/hr Natural Gas Burner, & 4 MMBtu/hr Natural Gas Condensate Evaporator	--	--	--	--	--
Anthony Forest Products Company	1681-AOP-R20	Dual Path Kiln #4	--	1	lb/hr	4.4	tpy
		Dual Path Kiln #4 Abort Stack	--	0.3	lb/hr	0.1	tpy

FGD and an acid gas scrubber are technically feasible for the system. However, the CDK burner fires green sawdust (i.e., wood) as its primary fuel, which is essentially sulfur free, so low sulfur fuel is technically feasible and already achieved by the process. Therefore, Weyerhaeuser proposes low sulfur fuels and proper maintenance and operating practices as BACT for SO₂ emissions from the CDK. Following guidance from Georgia EPD, Weyerhaeuser proposes 0.025 lb/MMBtu (or 1.25 lb/hr) as the SO₂ BACT emission limit.²⁰

5.2.6 tBACT Analysis for Toxic Air Pollutant Emissions

All TAPs emitted are emitted as VOC. Therefore, the BACT determinations listed for VOC emissions also satisfy tBACT requirements for this emission unit.

5.3 BACT Analysis for Paved Roads

5.3.1 BACT Analysis for PM Emissions

PM emissions consist of filterable and condensable particulate matter and are fugitive in nature. Based on the RBLC database results in Table 5-6, as well as existing air permits and applications for direct-fired CDK projects, the following control methods were identified for initial review:²¹

- ▶ Included in RBLC
 - Road Watering Plan
 - Good Housekeeping Practices
- ▶ Other Controls
 - Road Sweeping
 - Speed Reduction

²⁰ Georgia Environmental Protection Division’s (EPD) document entitled “EPD Recommended Emission Factors for Lumber Kiln Permitting in Georgia”.

²¹ RBLC search conducted on July 18, 2023 for roads under process code 30.999 with a permit date between 1/1/2012 and 7/18/2023.

Table 5-6. RBLC Results for PM Emissions from Paved Roads

Facility Name	Permit #	Process Name	Control Method	Pollutant	Emission Limit	Unit
El Dorado Sawmill	2348-AOP-R0	Haul Roads SN-09	Road Watering Plan + 0% Off-Site Opacity	TPM	12.7	lb/hr
Resolute FP – Catawba Lumber Mill	2440-0216-CA	Roads	Good Housekeeping Practices	Filterable PM (FPM)	0.13	lb/VMT
				FPM ₁₀	0.03	lb/VMT
				FPM _{2.5}	0.01	lb/VMT

The Facility currently waters for dust suppression daily and sweeps the roads twice-monthly, which controls 75% of fugitive PM emissions. Since watering and vacuuming provide the most effective control for dust, Weyerhaeuser will continue these practices following the CDK Project. Therefore, Weyerhaeuser proposes bi-weekly watering and vacuuming as BACT for PM emissions from the paved roads. As detailed in the emission calculations, Weyerhaeuser proposed emission factors from AP-42 Section 13.2.1, Paved Roads, using the average silt loading value for corn wet mills along with a control efficiency of 75%, as the most accurate PM BACT emission limits.

5.4 BACT Analysis for Material Handling

5.4.1 BACT Analysis for PM Emissions

PM emissions consist of filterable and condensable particulate matter from the following material transfers inside and outside of the sawmill:

- ▶ Fuel silo loading (via cyclone)
- ▶ Bark bins loading (via cyclone)
- ▶ Chip bins loading of planer shavings (via cyclone)
- ▶ Green sawdust sawmill drop point (fugitive)
- ▶ Bark bins truck loadout (fugitive)
- ▶ Chip bins truck loadout (fugitive)

Based on the RBLC database results in Table 5-7, as well as existing air permits and applications for direct-fired CDK projects, the following control methods were identified for initial review:²²

- ▶ Included in RBLC
 - Building Enclosure
 - Cyclone
 - Proper Maintenance and Operating Practices
- ▶ Other Controls
 - Fabric Filtration Systems (baghouse, bin vent filters, etc.)

²² RBLC search conducted on July 18, 2023 for roads under process code 30.999 with a permit date between 1/1/2012 and 7/18/2023.

Table 5-7. RBLC Results for PM Emissions from Material Handling

Facility Name	Permit #	Process Name	Control Method	Pollutant	Emission Limit	Unit
Two Rivers Lumber Co.	105-S007-X002	Sawmill	--	Fugitive PM	--	--
Talladega Sawmill	309-0075	Sawmill and Green End Operations	--	TPM	--	--
			--	TPM ₁₀	--	--
			--	TPM _{2.5}	--	--
El Dorado Sawmill	2348-AOP-R0	Sawmill SN-05	Sawmill located inside building	TPM	0.35	lb/ton
		Truck Bin SN-08	Cyclone; Proper Maintenance and Operation	TPM	0.002	gr/dscf
		Material Processing SN-11	Proper Maintenance and Operation	TPM	0.02	lb/ton
Resolute – Catawba Lumber Mill	2440-0216-CA	Material Transfer	Proper Maintenance and Good Operating Practices	FPM	0.0012	lb/ton
				FPM ₁₀	0.0005	lb/ton
				FPM _{2.5}	0.0001	lb/ton

Loading of green sawdust from the sawmill to the CDK fuel silo and loading of bark from the hog to the bark truck bins will each be controlled by a cyclone with airlocks. Since the Facility will employ the most effective control technology for this transfer, Weyerhaeuser proposes a cyclone as BACT for PM emissions from fuel silo loading and bark bin loading. Following guidance in ORCAA’s Annual Emissions Inventories for the Facility, Weyerhaeuser proposes 0.03 gr/dscf as the PM BACT limit for these transfers. Transfer of dry chips from the planer mill to the chip bins will also be controlled by a cyclone with airlocks, but the cyclone exhaust will further be controlled by a baghouse with a 99% control efficiency, due to the low moisture content of this stream. Weyerhaeuser proposes a cyclone and baghouse as BACT for PM emissions from chip bin loading of dry chips. Further, Weyerhaeuser proposes application of a 99% control efficiency onto emissions calculated with ORCAA’s 0.03 gr/dscf grain loading rate as the PM BACT limit for this transfer.

For the new green sawdust drop point, the material transfer is located within the building enclosure. Neither a cyclone nor a fabric filtration system is feasible for this drop, so Weyerhaeuser proposes the building enclosure as BACT for PM emissions from the green sawdust sawmill drop point. As shown in the emission calculations, Weyerhaeuser proposes methods from AP-42 Section 13.2.4, Aggregate Handling and Storage Piles, with the minimum wind speed (representing the indoor transfer), as the PM BACT limit for this transfer.

While the bark and chip truck bins will have a cyclone on top of each set of bins, loadout of the materials into trucks will not be controlled by such cyclones. No add-on control technologies already presented are technically feasible for truck bin loadout, besides proper maintenance and operating practices. However, the Facility plans to install steel sidings on two out of four sides of the truck bin drop points, which will reduce fugitive PM emissions by 50%. Therefore, Weyerhaeuser proposes steel sidings as BACT for PM emissions from the bark and chip bins truck loadout. Similar to the green sawdust sawmill drop point, Weyerhaeuser,

proposes methods from AP-42 Section 13.2.4, Aggregate Handling and Storage Piles, but instead with the mean wind speed (representing the outdoor transfer), as the PM BACT limit for the truck loadout transfers.

6. MODELING METHODOLOGY

This section of the application report presents the procedures that are utilized to perform the air dispersion modeling analysis.

6.1 Model Selection

Version 22112 of the AERMOD model is used to estimate maximum ground-level concentrations in the air dispersion analysis. AERMOD is a refined, steady-state, multi-source, air dispersion model used for industrial sources.²³

The NO₂ modeling followed the three tier NO₂ modeling approach for the conversion of nitric oxide (NO) to NO₂ described in EPA's Guideline Section 4.2.3.4. The three tiers are:

- ▶ Tier 1 – Total Conversion of NO_x to NO₂
- ▶ Tier 2 – Ambient Ratio Method 2 (ARM2)
- ▶ Tier 3 – Ozone Limiting Method (OLM) or Plume Volume Molar Ratio Method (PVMRM)

The models prepared for this application use ARM2 with default ambient ratios for the NO₂ modeling demonstration. The ARM2 method multiplies the modeled NO_x impacts by estimates of representative NO₂/NO_x equilibrium ratios based on ambient levels of NO₂ and NO_x. The national default for ARM2 includes a minimum ambient NO₂/NO_x ratio of 0.5 and a maximum ambient ratio of 0.9.

6.2 Meteorological Data

AERMOD-ready meteorological data for the period 2016 - 2020 was prepared using the U.S. EPA's AERMET meteorological processing utility (version 19191). Standard U.S. EPA meteorological data processing guidance was used as outlined in a recent memorandum²⁴ and other documentation.

6.2.1 Surface Data

Raw hourly surface meteorological was obtained from the U.S. National Climactic Data Center (NCDC) for Hoquiam Bowerman Airport (KHQM, WMO ID: 727923) in the standard ISHD format. This data was supplemented with TD-6405 (so-called "1-minute") wind data from KHQM for 2016-2020. The 1-minute wind data was processed using the latest version of the U.S. EPA AERMINUTE pre-processing tool (version 15272). Quality of the 1-minute data was verified by comparison to the hourly ISHD data from KHQM, which showed only small differences typical of 1-minute and hourly wind data comparisons. The "Ice-Free Winds Group" AERMINUTE option was selected due to the fact that a sonic anemometer was used at KHQM for the entire period. Figure 6-1 shows the distribution of wind speed and direction for the site.

²³ 40 CFR 51, Appendix W–*Guideline on Air Quality Models*, Appendix A.1– AMS/EPA Regulatory Model (AERMOD).

²⁴ Fox, Tyler, U.S. Environmental Protection Agency. 2013. "Use of ASOS Meteorological Data in AERMOD Dispersion Modeling." Available Online:
https://www.epa.gov/sites/default/files/2020-10/documents/20130308_met_data_clarification.pdf

Figure 6-1. 2016-2020 Wind Rose for Hoquiam Bowerman Airport (KHQM)

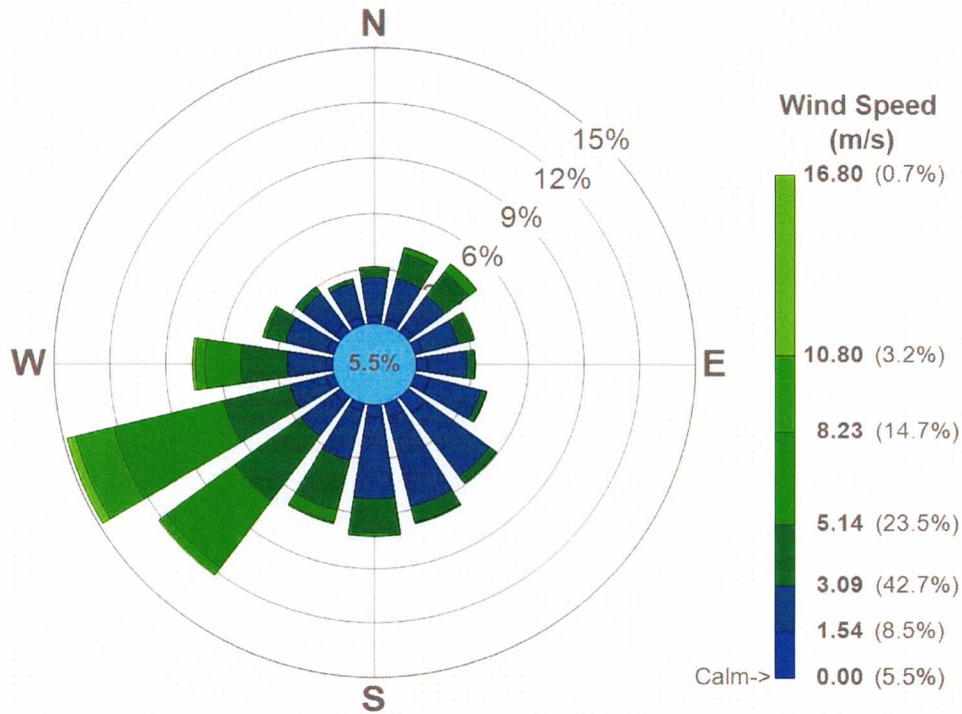

6.2.2 Upper Air Data

In addition to surface meteorological data, AERMET requires the use of data from a near-sunrise-time upper air sounding to estimate daytime mixing heights. Upper air data from the nearest U.S. National Weather Service (NWS) upper-air balloon station, located in Quillayute, WA (UIL), was obtained from the National Oceanic and Atmospheric Administration (NOAA) in FSL format.

6.2.3 Land Use Analysis

Parameters derived from analysis of land use data (surface roughness, Bowen ratio, and albedo) are also required by AERMET. In accordance with U.S. EPA guidance, these values were determined using the latest version of the U.S. EPA AERSURFACE tool (version 20060).²⁵ The AERSURFACE settings used for processing are summarized in Table 6-1, below. The met station coordinates were determined by visually identifying the met station using Google Earth. NLCD 2016 (CONUS) Land Cover data, Canopy data, and Impervious data used in AERSURFACE processing were obtained from the Multi-Resolution Land Use Consortium (MRLC).

U.S. EPA guidance dictates that on at least an annual basis, precipitation at a surface site should be classified as wet, dry, or average in comparison to the 30-year climatological record at the site. This determination is used to adjust the Bowen ratio estimated by AERSURFACE. To make the determination,

²⁵ U.S. Environmental Protection Agency. February 2020. "User's Guide for AERSURFACE Tool." EPA-454/B-20-008. Available Online: https://gaftp.epa.gov/Air/aqmg/SCRAM/models/related/aersurface/aersurface_ug_v20060.pdf

annual precipitation in each modeled year (2016-2020) was compared to the 1991-2020 climatological record for KHQM. The annual precipitation data is from the Climate Data Online platform provided by NOAA National Centers for Environmental Information. The 30th and 70th percentile values of the annual precipitation distribution from 1991-2020 were calculated. Per U.S. EPA guidance, each modeled year was classified for AERSURFACE processing as "wet" if its annual precipitation was higher than the 70th percentile value, "dry" if its annual precipitation was lower than the 30th percentile value, and "average" if it was between the 30th and 70th percentile values. The values used in this case are included in Table 6-1.

Table 6-1.AERSURFACE Input Parameters

AERSURFACE Parameter	Value
Met Station Latitude	46.972881
Met Station Longitude	-123.930743
Datum	NAD 1983
Radius for surface roughness (km)	1.0
Vary by Sector?	Yes
Number of Sectors	12
Temporal Resolution	Seasonal
Continuous Winter Snow Cover?	No
Station Located at Airport?	Airport Sector: 3, 4, 8-10 Non-Airport Sector: 1, 2, 5-7, 11, 12
Arid Region?	No
Surface Moisture Classification	Dry (2019) Average (2017, 2018, and 2020) Wet (2016)

U.S. EPA recommendations were used to specify the area used for the AERSURFACE analysis. Surface roughness was estimated based on land use within a 1 km radius of the meteorological station, with directional variation in roughness accounted for by using the maximum of twelve thirty-degree sectors. Albedo and Bowen ratio were estimated based on a 10x10 km box centered on the meteorological station. Figure 6-2 shows the areas used for the land use analysis.

Figure 6-2. Areas Used for AERSURFACE Land Use Analysis

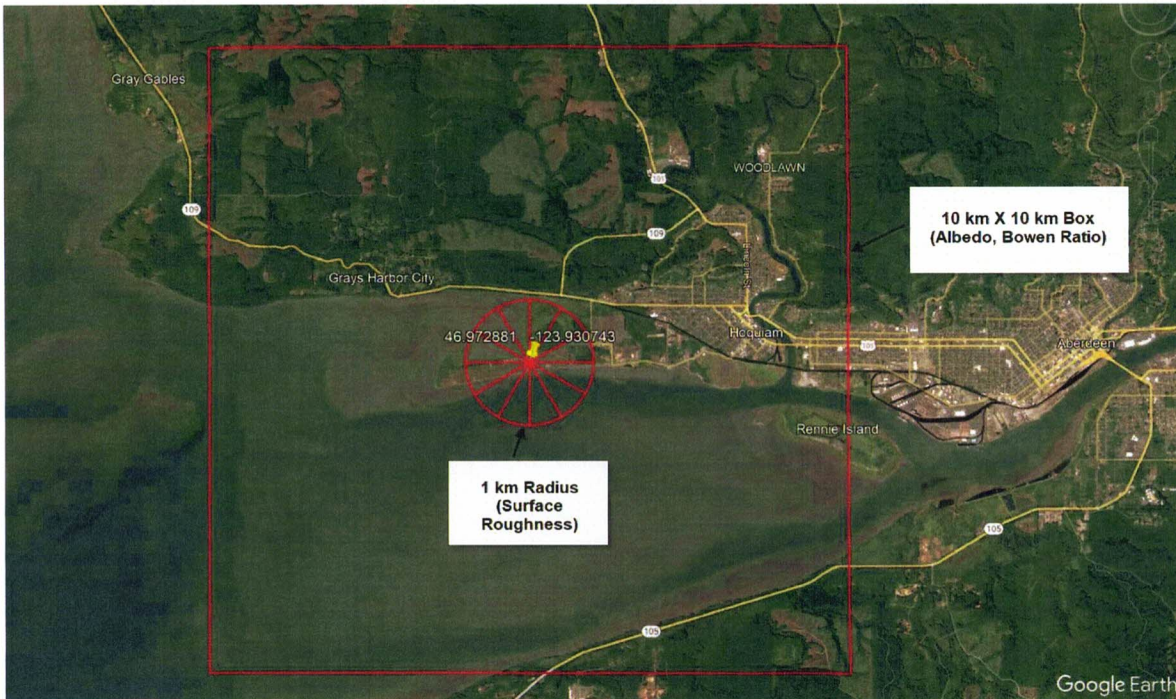

6.2.4 AERMET Processing Options

Standard AERMET processing options were used in this case^{26,27}, with the exception of the ADJ_U* option. The options elected include:

- ▶ MODIFY keyword for upper air data
- ▶ THRESH_1MIN 0.5 keyword to provide a lower bound of 0.5 m/s for 1-minute wind data
- ▶ AUDIT keywords to provide additional QA/QC and diagnostic information
- ▶ ASOS1MIN keyword to incorporate 1-minute wind data
- ▶ NWS_HGT WIND 10 keyword to designate the anemometer height as 10 meters
- ▶ METHOD WIND_DIR RANDOM keyword to correct for any wind direction rounding in the raw ISHD data
- ▶ METHOD REFLEVEL SUBNWS keyword to allow use of airport surface station data
- ▶ Default substitution options for cloud cover and temperature data were not overridden
- ▶ Default ASOS_ADJ option for correction of truncated wind speeds was not overridden
- ▶ ADJ_U* option was used

²⁶ Fox, Tyler, U.S. Environmental Protection Agency. 2013. "Use of ASOS Meteorological Data in AERMOD Dispersion Modeling." Available Online: https://www.epa.gov/sites/default/files/2020-10/documents/20130308_met_data_clarification.pdf

²⁷ U.S. Environmental Protection Agency. 2019. "User's Guide for the AERMOD Meteorological Preprocessor (AERMET)". EPA-454/B-19-028, August, 2019).

The ADJ_U* option adjusts the surface friction velocity parameter (U*) used by AERMET in certain low wind speed situations. This option, based on a peer-reviewed study²⁸, was added to AERMET by U.S. EPA to address the tendency of AERMET/AERMOD to underestimate dispersion and thus overestimate ground-level pollutant concentrations for low-level sources under low wind speed conditions, and became a default regulatory option with U.S. EPA's 2017 revision to the Guideline on Air Quality Models.²⁹

6.3 Coordinate System

The locations of receptors, buildings and sources are represented in the Universal Transverse Mercator (UTM) coordinate system using the World Geodetic System, 1984 projection. The UTM grid divides the world into coordinates that are measured in north meters (measured from the equator) and east meters (measured from the central meridian of a particular zone, which is set at 500 km)/ UTM coordinates for this analysis are based on UTM zone 10. The location of the Raymond Facility is approximately 5,170,748 m Northing and 443,644 m Easting in UTM zone 10.

6.4 Terrain Elevations

Terrain elevations for receptors, buildings, and sources are determined using National Elevation Dataset (NED) supplied by the United States Geological Survey (USGS). The NED is a seamless dataset with the best available raster elevation data of the contiguous United States. NED data retrieved for this model have a grid spacing of 1/3 arc-second or 10 m. The AERMOD preprocessor, AERMAP v18081, is used to compute model object elevations from the NED grid spacing. AERMAP also calculates hill height data for all receptors. All data obtained from the NED files are checked for completeness and spot-checked for accuracy.

6.5 Urban / Rural Determination

The Facility is located in Raymond, Washington on the Willapa River. Raymond is a city with a population of approximately 3,000 people at the time of the 2020 census. Outside of the city, most of the land use is not considered urban (medium to high intensity developed land). For the purposes of this model, it is conservatively assumed that the area surrounding the Facility does not meet the definition of urban land use. Therefore, the urban option is not selected in AERMOD.

²⁸ Qian and Venkatram. 2011. "Performance of Steady-State Dispersion Models Under Low Wind-Speed Conditions." *Boundary-Layer Meteorology*, Volume 138, Issue 3, pp 475-491.

²⁹ U.S. Environmental Protection Agency. 2017. "Guideline on Air Quality Models." 40 CFR Part 51, Appendix W. https://www.epa.gov/sites/default/files/2020-09/documents/appw_17.pdf

6.6 Receptor Grid

The model has receptors along the fenceline spaced 12.5 m apart. There is also a variable density, square Cartesian receptor grid extending 10,000 m from the center of the Facility. This receptor grid spacing is set up according to the following list:

- ▶ 12.5-meter spacing for at least the first 150 meters from the Facility fenceline;
- ▶ 25-meter spacing for the first 650 meters from the center of the Facility;
- ▶ 50-meter spacing from 650 to 1,150 meters from the center of the Facility;
- ▶ 100-meter spacing from 1,150 to 2,250 meters from the center of the Facility;
- ▶ 300-meter spacing from 2,250 to 4,650 meters from the center of the Facility; and
- ▶ 600-meter spacing from 4,650 to 10,000 meters from the center of the Facility.

All model receptors are placed at a flagpole height of 1.5 meters. Maps of the receptors are shown in Figure 6-3 and Figure 6-4 below. The Facility is shown in Figure 6-5 below with the fenceline represented by the purple outline surrounding the Facility with included buildings.

Figure 6-3. Zoomed Out Receptor Grid



Figure 6-4. Zoomed In Receptor Grid

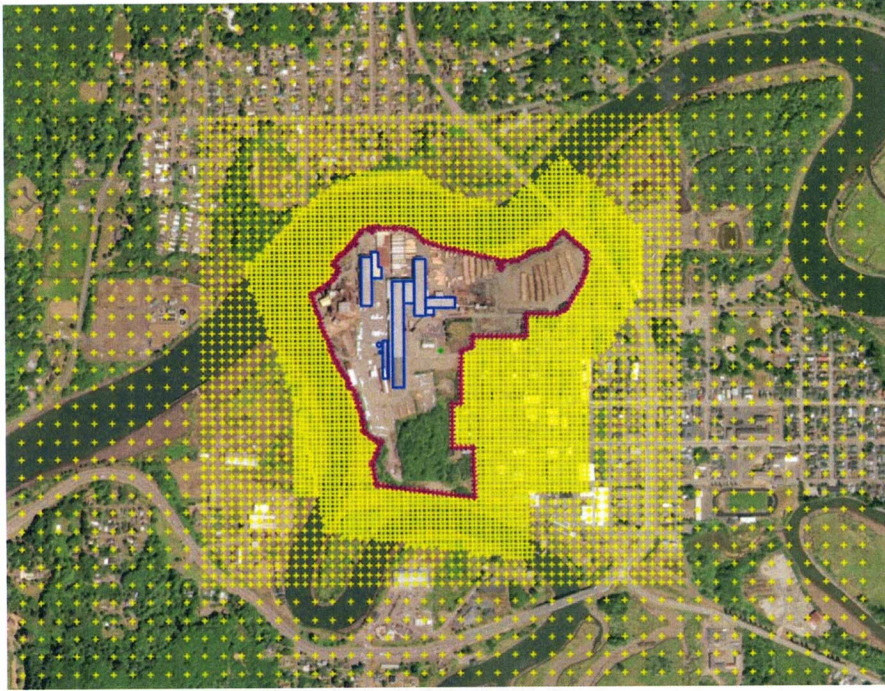
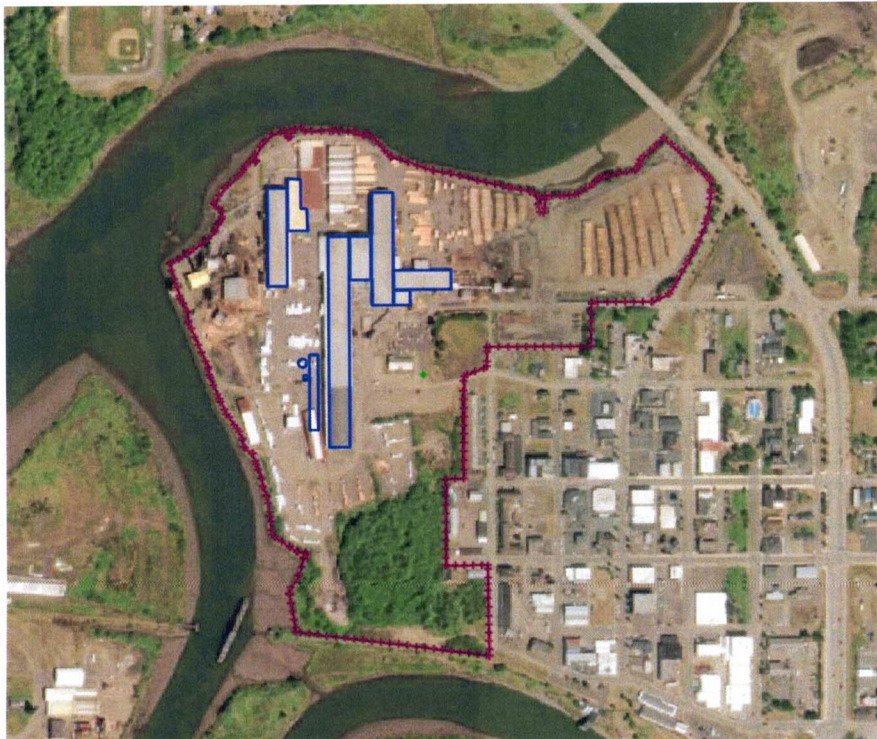

Figure 6-5. Facility Fenceline



6.7 Building Downwash

Emissions from each source will be evaluated in terms of their proximity to nearby structures. The purpose of this evaluation is to determine if stack discharges might become caught in the turbulent wakes of these structures. Wind blowing around a building creates zones of turbulence that are greater than if the buildings were absent. The concepts and procedures expressed in the GEP Technical Support document, the User's Guide to the Building Profile Input Program, and other related documents will be applied to all structures at the Raymond Facility. The Building Profile Input Program for PRIME (BPIPPRM) Version 04274 is used to calculate the downwash values for each point source. See Appendix G for a table of building heights.

6.8 Source Types and Parameters

Emission releases from the equipment onsite are represented in the model as point sources, horizontal point sources, and volume sources. Emission unit parameters are based on vendor quotes and specifications of existing equipment. Volume source parameters are based on dimensions of nearby structures or obstructions according to the User's Guide for the AMS/EPA Regulatory Model (AERMOD). Emissions for all sources are on a PTE basis and are the maximum expected emissions from Facility operations as described in Section 3. The current Facility site layout is provided in Appendix B.

The modeling parameters for the sources are determined based on the following and are included in Appendix G:

- ▶ Exhaust temperature, exhaust flowrate/velocity, stack height, and stack diameter are obtained from the CDK vendor and engineering firm for all new point sources.
- ▶ Exhaust temperature, exhaust flowrate/velocity, stack height, and stack diameter are obtained from historical Weyerhaeuser permit documentation for all existing sources.
- ▶ Haul road volume source parameters are determined using the dimensions of an average haul truck and the EPA guidance memo on haul roads³⁰.
- ▶ Emission rates are based on PTE calculations as described in Section 3 for all sources.

The stacks for the CDK will be spaced closely enough for the exhaust plumes to merge, enhancing plume rise. AERMOD does not explicitly account for this enhanced plume rise. However, the use of a pseudo stack diameter in AERMOD based on the total volume flow rate of the adjacent stacks properly accounts for the enhanced plume rise. EPA has allowed this technique on a case-by-case basis.³¹ The judgement as to whether combining flows is appropriate includes:

- ▶ Stack locations – Only stacks located within 1 diameter of each other are treated as a merged source.
- ▶ Stack height and diameter – All of the stacks treated as a merged source have the same stack height and diameter.
- ▶ Stack emission parameters (temperature, momentum or volume flow, emission rates, etc.) - All of the stacks treated as a merged source have the same emission parameters.

The proposed stack arrangement meets these criteria, and the EPA-accepted merged plume technique is used in the modeling analysis. The PSD regulations (40 CFR 51.118(a) and 40 CFR 52.21(h)) contain limits

³⁰ EPA memo Haul Road Workgroup Final Report Submission to EPA-OAQPS, dated March 2, 2012.

³¹ Model Clearinghouse Information Storage and Retrieval System Record Details - OH GM Defiance Bubble (97-V-02)

on the use of other dispersion techniques. Dispersion techniques are defined in 40 CFR 51.100(hh)(1) as "any technique which attempts to affect the concentration of a pollutant in the ambient air by...increasing final exhaust gas plume rise by... selective handling of exhaust gas streams so as to increase the exhaust gas plume rise." However, 40 CFR 51.100(hh)(2) exempts the merging of exhaust gas streams when the facility is originally designed and constructed with merged gas streams.

7. MODELING ANALYSIS

7.1 TAP Modeling

Dispersion modeling is conducted to demonstrate compliance with the Washington TAP program in WAC 173-460 as adopted by ORCAA. WAC 173-460 established a Small Quantity Emission Rate (SQER) and ASIL for each listed TAP. An *acceptable source impact analysis* must be conducted for each TAP with an emission increase. The toxics rule, in WAC 173-460-080(2) allows for applicants to satisfy the acceptable source impact limit if emissions are below the SQER for each TAP. As shown in Table 3-2 above, several pollutants are above their respective SQER; therefore, dispersion modeling is required.

All modeled TAPs must be below the respective ASIL listed in WAC 1703-460-150 to demonstrate compliance. All TAPs, except NO₂, are modeled at 1 gram per second (g/s) and scaled using the project emission increase per WAC 173-460-080. The high first high results from the NAAQS models for NO₂ described in Sections 6.1 and 7.2 are used for the TAP results. The model results are determined based on the maximum concentration increase across all receptors and model years. Results in Table 7-1 below show that acetaldehyde and formaldehyde exceed their respective ASIL; therefore, a Tier II Health Impact Assessment is completed and submitted under separate cover.

Table 7-1. TAP Model Results

Pollutants	Averaging Period	Highest Modeled Concentration (µg/m³)	ASIL (µg/m³)	Exceeds ASIL?
Acetaldehyde	year	0.93	0.37	Yes
Acrolein	24-hr	0.12	0.35	No
Formaldehyde	year	0.29	0.17	Yes
Nitrogen dioxide	1-hr	129	470	No
Sulfur dioxide	1-hr	23.87	660	No

7.2 NAAQS Modeling

Dispersion modeling is conducted to determine whether increases in PM₁₀, PM_{2.5}, CO, NO₂, and SO₂ from the project are insignificant or significant (below or above the Significant Impact Level [SIL]). The SIL model concentrations exceed the SIL for all given pollutants other than CO. Therefore, dispersion modeling is conducted to demonstrate compliance with the NAAQS.

In a cumulative NAAQS analysis, the scope of the analysis is expanded from the SIL analysis to include impacts from nearby sources by including background concentrations. Background concentrations in Table 7-2 are obtained from NW Airquest³². For each pollutant and averaging period, the concentration of the closest grid point to the Facility is used.

³² NW Airquest is housed through Idaho Department of Environmental Quality. It provides criteria pollutant background concentrations through model and monitoring data from July 2014 through June 2017.

<https://idahodeq.maps.arcgis.com/apps/MapSeries/index.html?appid=0c8a006e11fe4ec5939804b873098dfe>

Table 7-2. Background Concentrations

Pollutant	Averaging Period	Background Concentration (µg/m³)
PM ₁₀	24-hr	42.7
PM _{2.5}	24-hr	10.2
	Annual	4.3
NO ₂	1-hr	21.8
	Annual	4.3
SO ₂	1-hr	12.3

The modeled PTE for the Facility can be found in Table 7-3 below. All criteria pollutant concentrations are below the NAAQS. Therefore, compliance with the NAAQS for the proposed project is demonstrated. The mapped NAAQS results are included in Table 7-3.

Table 7-3. NAAQS Model Results

Pollutant	Averaging Period	Design Concentration	Concentrations (µg/m³)			Exceeds NAAQS?
			Modeled	Total	NAAQS	
PM ₁₀	24-hr	H6H	71.3	114.0	150	No
PM _{2.5}	24-hr	H8H	17.4	27.6	35	No
	Annual	--	4.64	8.9	12	No
NO ₂	1-hr	H8H	101	123	188	No
	Annual	--	8.4	12.7	100	No
SO ₂	1-hr	H4H	15.9	28.2	196	No

APPENDIX A. APPLICATION FORMS

OLYMPIC REGION CLEAN AIR AGENCY

2940 Limited Lane NW - Olympia, Washington 98502 - 360-539-7610 – Fax 360-491-6308

FORM 1- NOTICE OF CONSTRUCTION

TO CONSTRUCT - INSTALL - ESTABLISH OR MODIFY AN AIR CONTAMINANT SOURCE

Form 1 Instructions:

1. Please complete all the fields below. **This NOC application is considered incomplete until signed.**
2. If the application contains any confidential business information, please complete a Request of Confidentiality of Records (www.orcaa.org).
3. Duty to Correction Application: An applicant has the duty to supplement or correct an application. Any applicant who fails to submit any relevant facts or who has submitted incorrect information in a permit application must, upon becoming aware of such failure or incorrect submittal, promptly submit supplementary factors or corrected information.

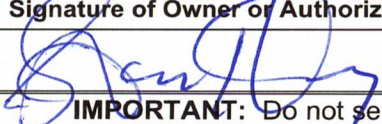
Business Name: Weyerhaeuser Raymond Lumbermill	For ORCAA use only File No: 475 County No: 49 Source No: 4 Application No: 23 NOC1614
Mailing Address: 51 Ellis Street, Raymond, WA 98577	Date Received: <div style="text-align: center; color: red; font-weight: bold; font-size: 1.2em;"> Received SEP 08 2023 ORCAA </div>
Physical Address of Project or New Source: 51 Ellis Street, Raymond, WA 98577	
Billing Address: 51 Ellis Street, Raymond, WA 98577	
Project or Equipment to be installed/established: Direct-Fired Continuous Dry Kiln (CDK) to replace the batch dry kilns. Two truck bins. Cyclone for green sawdust fuel silo. Related material transfer conveyors and drops.	
Anticipated startup date: <u>11</u> / <u> </u> / <u>2024</u> Is facility currently registered with ORCAA? Yes <input checked="" type="checkbox"/> No <input type="checkbox"/>	
This project must meet the requirements of the State Environmental Policy Act (SEPA) before ORCAA can issue final approval. Indicate the SEPA compliance option: <input type="checkbox"/> SEPA was satisfied by _____ (government agency) on ___/___/___ (date) - Include a copy of the SEPA determination <input type="checkbox"/> SEPA threshold determination by _____ (government agency) is pending - Include a copy of the environmental checklist <input checked="" type="checkbox"/> ORCAA is the only government agency requiring a permit - Include ORCAA Environmental Checklist <input type="checkbox"/> This project is exempt from SEPA per _____ (WAC citation).	
Name of Owner of Business: Weyerhaeuser NR Company	Agency Use Only
Title:	
Email:	Phone:
Authorized Representative for Application (if different than owner): Spencer Headley	
Title: Raymond Lumber Mill Manager	
Email: spencer.headley@weyerhaeuser.com	Phone: 360-942-6309
I hereby certify that the information contained in this application is, to the best of my knowledge, complete and correct.	
Signature of Owner or Authorized Representative: (sign in Blue Ink)	
	Date: 9/6/2023
IMPORTANT: Do not send via email or other electronic means. ORCAA must receive Original, hardcopy, signed application and payment prior to processing application.	

OLYMPIC REGION CLEAN AIR AGENCY

2940 Limited Lane NW - Olympia, Washington 98502 - 360-539-7610 – Fax 360-491-6308

FORM 1D- Contact Information

Business Name Weyerhaeuser NR Company	FOR ORCAA USE
	FILE #
Physical Site Address (Street address, city, state, zip) 51 Ellis St Raymond, WA 98577	CTY #
	SRC #
	Date Received Received SEP 08 2023 ORCAA
Previous Business Name (if applicable)	

Contact Information

Inspection Contact	
Name Spencer Headley	Title Raymond Lumber Mill Manager
Phone 360-942-6309	Email spencer.headley@weyerhaeuser.com
Billing Contact	
Name Angela Cameron	Title Facility Environmental Manager
Phone 360-414-3464	Email angela.cameron@weyerhaeuser.com
Emission Inventory Contact	
Name Angela Cameron	Title Facility Environmental Manager
Phone 360-414-3464	Email angela.cameron@weyerhaeuser.com
Complaint Contact	
Name Angela Cameron	Title Facility Environmental Manager
Phone 360-414-3464	Email angela.cameron@weyerhaeuser.com
Permit Contact	
Name Angela Cameron	Title Facility Environmental Manager
Phone 360-414-3464	Email angela.cameron@weyerhaeuser.com

The **inspection contact** is the on-site person responsible for the everyday operation of the site and is available for inspections.

The **billing contact** is the person invoices are sent.

The **emission inventory contact** is the person requests for emissions information and material use information are sent.

The **complaint contact** is the person who receives and responds to complaints received on-site and who is contacted regarding complaints ORCAA receives.

The **permit contact** is the person responsible for filling out permit applications and receiving approval from ORCAA.

FORM 4
FACILITY EMISSIONS SUMMARY

Facility: Weyerhaeuser Raymond Lumbermill

Instructions: on back.

Emission Unit ID#	TSP	PM-10	SOx	NOx	VOC	CO
See attached NOC application.						
Facility Total						

FORM 5
EMISSIONS OF HAZARDOUS AIR POLLUTANTS

Facility: Weyerhaeuser Raymond Lumbermill Emission Unit ID#: ALL

Page ___ of ___

Pollutant Name	CAS #	Maximum Emission Rate (lbs/hr)	Annual Emission Rate (tons/yr)
See attached NOC application.			
Facility Total			

FORM 6 BACT ANALYSIS TABLE

Emission Unit: See attached NOC application.							
CONTROL OPTIONS	CONTROL EFFICIENCY (% removal)	POTENTIAL EMISSIONS (lbs/hr)	EXPECTED EMISSIONS (tons/yr)	ANNUAL EMISSION REDUCTIONS (tons)	ANNUAL COST (\$)	COST EFFECTIVENESS (\$/ton)	ENERGY, ENVIRONMENTAL ECONOMIC IMPACTS (list)
1.							
2.							
3.							
4.							
5.							
6.							

OLYMPIC REGION CLEAN AIR AGENCY

2940 Limited Lane NW - Olympia, Washington 98502 - 360-539-7610 – Fax 360-491-6308

FORM 12 BAGHOUSE

GENERAL INFORMATION		
Facility Name: Weyerhaeuser Raymond Lumbermill	Contact Person: Angela Cameron Phone Number: 360-414-3464 Email: angela.cameron@weyerhaeuser.com	
Facility Operating Schedule: 20 hrs/day, 5 days/wk, 52 wks/yr	Baghouse Operating Schedule: 20 hrs/day, 5 days/wk, 52 wks/yr	
Check days when operating: M <input checked="" type="checkbox"/> T <input checked="" type="checkbox"/> W <input checked="" type="checkbox"/> Th <input checked="" type="checkbox"/> F <input checked="" type="checkbox"/> Sat <input checked="" type="checkbox"/> Sun	Check days when operating: M <input checked="" type="checkbox"/> T <input checked="" type="checkbox"/> W <input checked="" type="checkbox"/> Th <input checked="" type="checkbox"/> F <input checked="" type="checkbox"/> Sat <input checked="" type="checkbox"/> Sun	
<input type="checkbox"/> new unit installation <input type="checkbox"/> modification	Manufacturer: Superior Systems, Inc	Model & Serial #s: Filter Model P12-338-12
TECHNICAL SPECIFICATIONS		
Air Flow: design acfm 40000 operating acfm 40000 temperature (F°) Ambient	System Parameters: pressure drop (inches water) TBD water vapor content (lbs water/lb dry air) TBD fan power (hp) 200	
Describe filter material: 5,070 sq. ft. of cloth, 16 oz. polyester felt bags, snap-in style, with galvanized bag cages. Weight of filter and frame is 4,500 lbs.		
Describe bag cleaning mechanism and cycle: TBD		
Describe operation of baghouse including use of safety bypasses, monitoring and maintenance schedules and any other pertinent information relating to particulate emissions (use additional pages if necessary): TBD		
PARTICULATE EMISSIONS DATA		
Particulate Emissions: inlet (gr/scf) <u>0.03</u> outlet (gr/scf) <u>TBD</u>	Particulate Control Efficiency: filtering velocity (acfm/ft ² cloth) TBD particulate control efficiency (%): 99	
Describe Particulate Emissions: The baghouse will control PM from the dry chip cyclone's exhaust stream. Controlled hourly emission rates for PM/PM10/PM2.5 are 0.0132/0.00530/0.00530 lb/hr. Controlled annual emissions rates are 0.03/0.0138/0.0138 tpy.		
Micron Range:	Inlet Loading (% of total)	Outlet Loading (% of total)
0 - 5	_____ %	_____ %
5 - 10	_____ %	_____ %
greater than 10	_____ %	_____ %
OTHER INFORMATION		
The following information is needed to complete the application: 1. Manufacturer brochure or technical fact sheet for filter material. 2. Scaled technical drawings of the baghouse including top, side and interior views. 3. Manufacturer brochure or technical fact sheet for baghouse.		

Note: See back side of form for ORCAA approved equipment and operations.

REQUIREMENTS FOR NEW BAGHOUSES
ORCAA 1/4/96

1. **BACT for Particulate Control:** ORCAA may require demonstration of compliance based on measured stack grain loading in accordance to the procedures outlined in 40CFR Part 60 and in accordance with ORCAA's approved particulate source test procedures.

1.1 Low Temperature Process Streams - Grain Elevators, Barley Processing, Forest Products Dust, Large Cabinet Shops:

Particulate Limit: 0.01 gr/dscf
Opacity Limit: 5% for entire process stream.

These limits are appropriate for low temperature dust control when NOMEX bags are feasible.

1.2 High Temperature Process Streams - Ceramics, Metal Dust:

Particulate Limit: 0.01 gr/dscf
Opacity Limit: 5% for entire process stream.

1.3 Combustion Sources - Boilers, Asphalt Plants:

Particulate Limit: 0.02 gr/dscf (back half included)

Opacity Limit: 5% for entire process stream.

2. **Stack:** Emissions shall exit through a vertical stack at least 2 meters above the highest point of the baghouse. Permanent sampling ports and platforms shall be installed on the stack prior to commencement of operation. The sampling ports shall meet the requirements of 40, CFR Part 60, Appendix A, Method 1.

3. **Opacity Monitor (wood fired boilers):** Owners and operators of baghouses installed on wood fired boilers shall install, calibrate, maintain, and operate a continuous emissions monitoring system (CEMS) for continuously monitoring the boiler stack gas opacity prior to exiting to the atmosphere.

3.1 The opacity CEMS shall be certified and installed in accordance 40CFR Part 60, Performance Specification 1 (appendix B).

3.2 The opacity CEMS shall be equipped with a strip chart recorder or data acquisition system (DAS) capable of computing and recording stack gas opacity in three consecutive minute averages. The data acquisition system or strip chart recorder shall record and display opacity values to 0.5% opacity.

3.3 Prior to installation of the CEMS, the owner or operator shall provide ORCAA a written manufacturers certificate of conformance with Performance Specification 1.

3.4 An opacity CEMS quality assurance plan conforming with 40 CFR Part 60 Appendix F and the EPA publication "Recommended Quality Assurance Procedures for Opacity Continuous Emissions Monitoring Systems" (EPA 340/1-86-010) shall be developed and submitted to ORCAA for approval no later than 180 days after commencement of operation.

3.5 The opacity CEMS shall be operational and tested for compliance with 40 CFR Part 60, Appendix B Performance Specification 1 no later than 90 days after initial startup.

4. **Other:** Other requirements include; 1) monitoring of pressure drop across baghouse, 2) bag monitoring and maintenance schedule, 3) full set of replacement bags on-site, 4) emission inventory reporting, and 5) excess emissions reporting.

Company: Crow Engineering
Location: Weyerhaeuser Raymond, WA

Date: May 25, 2023

Specifications Sheet:

Superior Filter Model P12-338-12

1. 5,070 sq. ft. of cloth
2. 42' 0" overall height by 12' 3" \emptyset
3. 16 oz. polyester felt bags, snap-in style, no tools required
4. Galvanized bag cages
5. Walk-in clean air plenum (32" x 78" walk-in man door w/view window)
6. Explosion venting (65:1 vent ratio)
7. 3/16" mild steel plate welded construction
8. Adapter fitting on cone for level sensor, level indicator not included
9. 60° cone to 16" \emptyset outlet, flanged to match airlock
10. Hopper access door
11. Tangential inlet, flanged and punched
12. Clean-air outlet, flanged and punched
13. Support structure with 72" clearance under cone, seismic zone III design
14. Caged access ladder(s) with service platform(s)
15. Control box assembly, 120v, single phase
16. Weather-proof duplex outlet, 120v, single phase
17. Magnehelic pressure gauge kit
18. "Auto-clear" system for magnehelic gauge dirty-air side line
19. Purge-air pump package with 10 Hp TEFC motor and drives
20. Compressed air requirement for purge-arm activation (0.25 scfm @ 80 psi)
21. Purge arm compressed air/filter-regulator-lubricator set
22. One (1) coat red oxide primer, one (1) coat industrial enamel
23. One (1) year warranty on all parts and workmanship
24. Two (2) owner's manuals
25. Optional: Sprinkler heads, in top of clean air plenum

OLYMPIC REGION CLEAN AIR AGENCY

2940 Limited Lane NW - Olympia, Washington 98502 - 360-539-7610 – Fax 360-491-6308

NOC FORM 13 CYCLONES

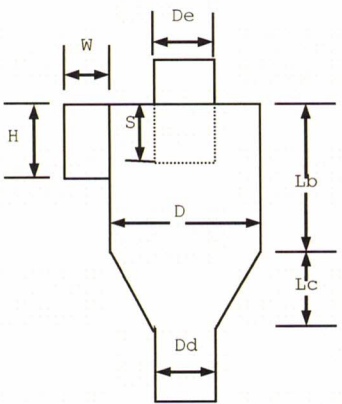
GENERAL INFORMATION		
Facility Name: Weyerhaeuser Raymond Lumbermill	Contact Person: Angela Cameron Phone Number: 360-414-3464 Email: angela.cameron@weyerhaeuser.com	
Facility Operating Schedule: 20 hrs/day, 5 days/wk, 52 wks/yr Check days when operating: M <input checked="" type="checkbox"/> W <input checked="" type="checkbox"/> Th <input checked="" type="checkbox"/> F <input checked="" type="checkbox"/> Sat <input checked="" type="checkbox"/> Sun	Cyclone Operating Schedule: 20 hrs/day, 5 days/wk, 52 wks/yr Check days when operating: M <input checked="" type="checkbox"/> W <input checked="" type="checkbox"/> Th <input checked="" type="checkbox"/> F <input checked="" type="checkbox"/> Sat <input checked="" type="checkbox"/> Sun	
1 new unit ___ modification ___ # identical units	Manufacturer: Kiln Drying Systems & Components, LLC	Model & Serial #s: HE 1400
TECHNICAL SPECIFICATIONS		
Air Flow: design acfm 6227 operating acfm 6227	System Parameters: pressure drop (inches water) 3 fan power (hp) 250 temperature (°F or ambient) Ambient	
Cyclone Design Parameters		
S (in.) 31.4961 H (in.) 27.5591 De (in.) 27.5591 Dd (in.) 20.4724 W (in.) 11.0236 D (in.) 55.11811 Lb (in.) 82.67717 Lc (in.) 131.8898		Describe location of cyclone including height and related stack (use additional pages if necessary): The cyclone will be fixed to the top of the fuel silo, which has a height of 84'-10". With the cyclone on top of the silo, the top of the exhaust stack will be at 122'-11.25". The elevation for the combined structure is 12'-6".
Describe operation of cyclone including use of safety bypass stacks (use additional pages if necessary): Green sawdust will be sent into the cyclone by blow pipe. Material will then go through the cyclone down into the fuel silo.		
PARTICULATE EMISSIONS DATA		
Describe Particulate Emissions: The drop down into the silo is enclosed by airlock, so there are no fugitive emissions anticipated. The stack exhausts to the atmosphere with a filterable PM grain loading rate of 0.03 gr/dscf, per ORCAA's AEI guidance. Additionally, PM10 is assumed to be approximately 40% of PM, also per ORCAA. PM2.5 is conservatively assumed to be equal to PM10.		
OTHER INFORMATION		
The following information is needed to complete the application: 1. Manufacturer brochure or technical fact sheet for cyclone.		

Note: See back side of form for ORCAA approved equipment and operations.

REQUIREMENTS FOR NEW CYCLONES ORCAA 1/4/96

1. **BACT for Particulate Control:** ORCAA may require demonstration of compliance based on measured stack grain loading in accordance Oregon DEQ Method 8.

1.1 Low Temperature Process Streams - Grain Elevators, Barley Processing, Forest Products Dust, Large Cabinet Shops:

Particulate Limit: 0.01 gr/dscf
Opacity Limit: 5% for entire process stream.

1.2 High Temperature Process Streams - Ceramics, Metal Dust:

Particulate Limit: 0.01 gr/dscf
Opacity Limit: 5% for entire process stream.

1.3 Combustion Sources - Boilers, Asphalt Plants:

Particulate Limit: 0.02 gr/dscf (back half included)

Opacity Limit: 5% for entire process stream.

2. **Stack (combustion units):** Emissions shall exit through a vertical stack at least 2 meters above the highest point of the combustion system. Permanent sampling ports and platforms shall be installed on the stack prior to commencement of operation. The sampling ports shall meet the requirements of 40, CFR Part 60, Appendix A, Method 1.

3. **Opacity Monitor (wood fired boilers):** Owners and operators of cyclones installed on wood fired boilers shall install, calibrate, maintain, and operate a continuous emissions monitoring system (CEMS) for continuously monitoring the boiler stack gas opacity prior to exiting to the atmosphere.

3.1 The opacity CEMS shall be certified and installed in accordance 40CFR Part 60, Performance Specification 1 (appendix B).

3.2 The opacity CEMS shall be equipped with a strip chart recorder or data acquisition system (DAS) capable of computing and recording stack gas opacity in three consecutive minute averages. The data acquisition system or strip chart recorder shall record and display opacity values to 0.5% opacity.

3.3 Prior to installation of the CEMS, the owner or operator shall provide ORCAA a written manufacturer's certificate of conformance with Performance Specification 1.

3.4 An opacity CEMS quality assurance plan conforming with 40 CFR Part 60 Appendix F and the EPA publication "Recommended Quality Assurance Procedures for Opacity Continuous Emissions Monitoring Systems" (EPA 340/1-86-010) shall be developed and submitted to ORCAA for approval no later than 180 days after commencement of operation.

3.5 The opacity CEMS shall be operational and tested for compliance with 40 CFR Part 60, Appendix B Performance Specification 1 no later than 90 days after initial startup.

4. **Other:** Other requirements may include; 1) visual monitoring opacity of cyclone emissions, 2) no fugitive leaks from dust collection system, 3) emission inventory reporting, and 4) excess emissions reporting.

27/03/03

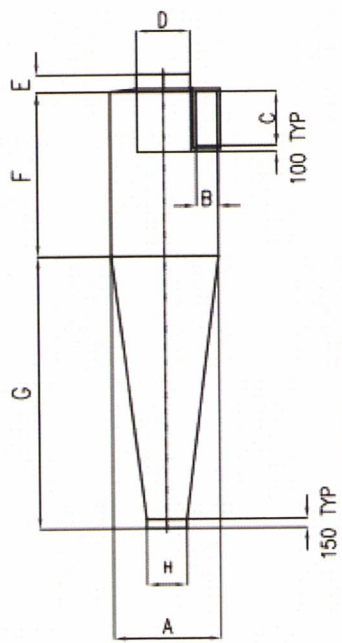

MODEL HE
 A HIGH EFFICIENCY
 MEDIUM PRESSURE
 DROP CYCLONE. SUITABLE
 FOR MOST APPLICATIONS.

GENERAL NOTES:
 1) "B", "C", "D" & "G" ARE
 INTERNAL DIMENSIONS.
 2) PRESSURE DROP @ NOM.
 AIRFLOW IS 750 Pa (3" W.G.)

MODEL	AIR FLOW		A	B	C	D	E	F	G	H	MATERIAL
	m ³ /s	CFM									
HE 1400	2.94	6227	1400	280	700	700	100	2100	3500	520	

APPENDIX B. SITE PLANS AND PROCESS FLOW DIAGRAM

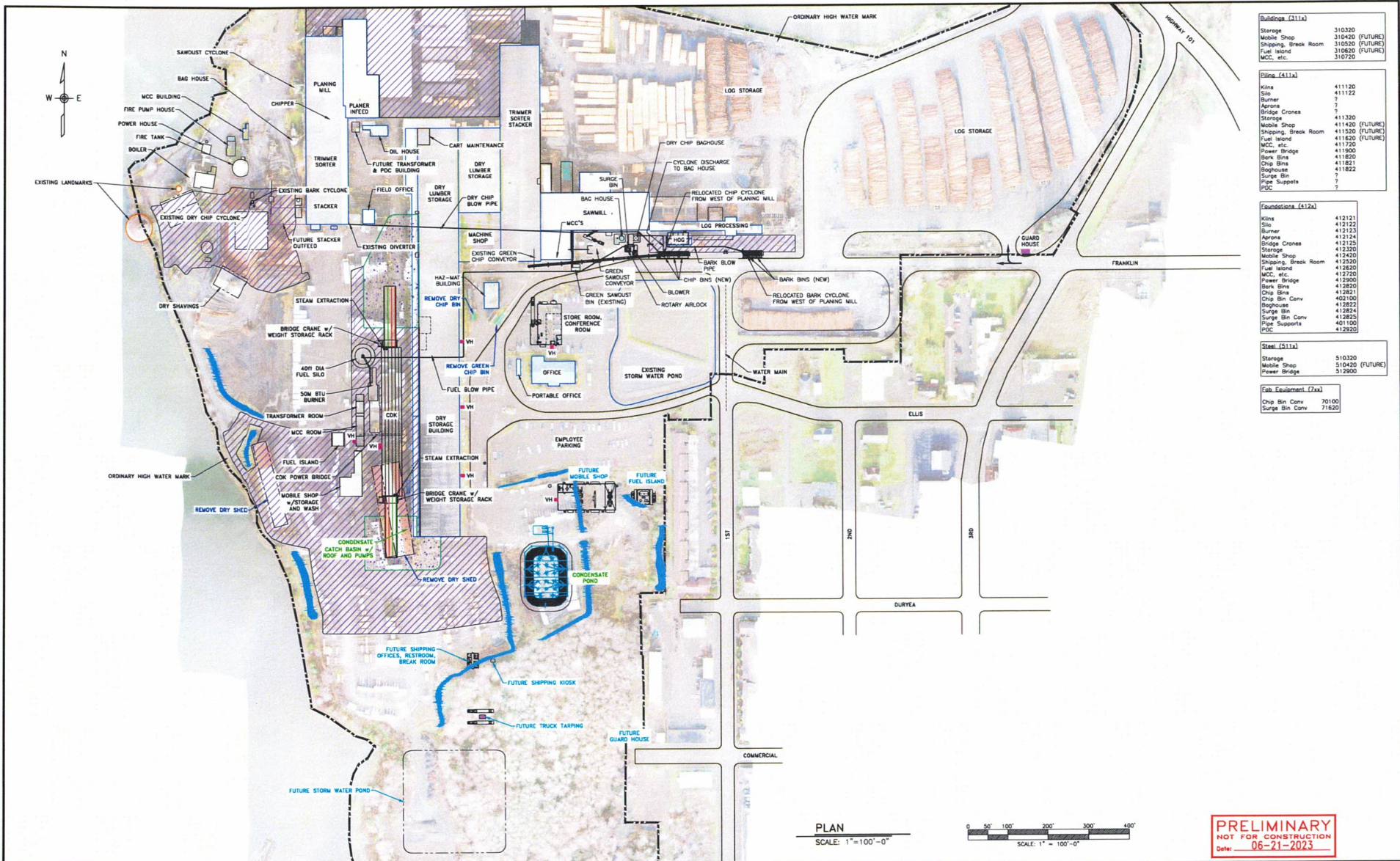

Buildings (A11a)	
Storage	310320
Mobile Shop	310420 (FUTURE)
Shipping Break Room	310520 (FUTURE)
Fuel Island	310620 (FUTURE)
MCC, etc.	310720

Pipes (A11a)	
Kines	411120
Silo	411122
Burner	?
Aprons	?
Bridge Cranes	411320
Storage	411420 (FUTURE)
Shipping Break Room	411520 (FUTURE)
Fuel Island	411620 (FUTURE)
MCC, etc.	411720
Power Bridge	411900
Bark Bins	411820
Chip Bins	411821
Baghouse	411822
Surge Bin	?
Pipe Supports	?
PDC	?

Foundations (A12a)	
Kines	412121
Silo	412122
Burner	412123
Aprons	412124
Bridge Cranes	412125
Storage	412220
Mobile Shop	412420
Shipping Break Room	412520
Fuel Island	412620
MCC, etc.	412720
Power Bridge	412800
Bark Bins	412820
Chip Bins	412821
Chip Bin Conv	402100
Baghouse	412824
Surge Bin Conv	412925
Pipe Supports	401100
PDC	412920

Steel (A11a)	
Storage	510320
Mobile Shop	510420 (FUTURE)
Power Bridge	512600

Job Equipment (F2a)	
Chip Bin Conv	70100
Surge Bin Conv	71820

PLAN
SCALE: 1"=100'-0"

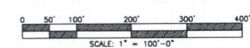

PRELIMINARY
NOT FOR CONSTRUCTION
Date: 06-21-2023

THESE PLANS AND SPECIFICATIONS AND THE ENGINEERING AND DESIGN WORK TO WHICH THEY PERTAIN, ARE HEREBY SOLELY FOR THE PRIVATE USE OF THE CLIENT. THE CLIENT SHALL BE RESPONSIBLE FOR OBTAINING ALL NECESSARY PERMITS AND APPROVALS FROM THE APPROPRIATE AGENCIES AND AUTHORITIES. THE CLIENT SHALL BE RESPONSIBLE FOR OBTAINING ALL NECESSARY PERMITS AND APPROVALS FROM THE APPROPRIATE AGENCIES AND AUTHORITIES. THE CLIENT SHALL BE RESPONSIBLE FOR OBTAINING ALL NECESSARY PERMITS AND APPROVALS FROM THE APPROPRIATE AGENCIES AND AUTHORITIES.

REV.	DATE	DESCRIPTION	BY	REV.	DATE	DESCRIPTION	BY
G	06-03	UPDATED DRAWING	DN				
F	06-03	UPDATED DRAWING	DN				
E	06-03	UPDATED DRAWING	DN				
K	06-14	ADDED STEAM EXTRACTION CALLOUTS TO CDK	SAC	D	06-03	RELOCATED BARK BLOWER CYCLONE	SAC
J	06-03	UPDATED DRAWING	DN	C	06-03	UPDATED DRAWING	DN
I	06-03	CDK WAS 20007-20	DN	B	06-03	UPDATED DRAWING	DN
H	06-03	UPDATED DRAWING	DN	A	06-03	UPDATED DRAWING	DN

THE PROFESSIONAL ENGINEER'S SEAL APPEARING ON THIS DRAWING APPLIES ONLY TO THE WORK AS SHOWN ON THIS DRAWING FOR THE ORIGINAL TITLE BLOCK DESIGNATION. ANY ALTERATION OR REUSE OF THIS DRAWING WITHOUT THE WRITTEN CONSENT OF THE ENGINEER IS PROHIBITED.

CROW ENGINEERING CIVIL STRUCTURAL MECHANICAL
9925 SW Nimbus Ave., Suite 110
Beaverton, OR 97008-7592
p (503) 213-2013
f (503) 213-2018
crowengineering.com

Weyerhaeuser
Raymond, Washington

**PLANT MODERNIZATION
CDK
SITE PLAN**

DRWN	CHECKED	SCALE	DATE	DRAWING NO.	REV.
DN		1"=100'-0"	06-22-22	20348-20	K

PILOT: 06/21/2023 10:08:25AM dm
SAVE: 15:08:2023-06-21 06:21:00 AM 100010-02_v1.dwg 06/21/23 08:31:31 AM

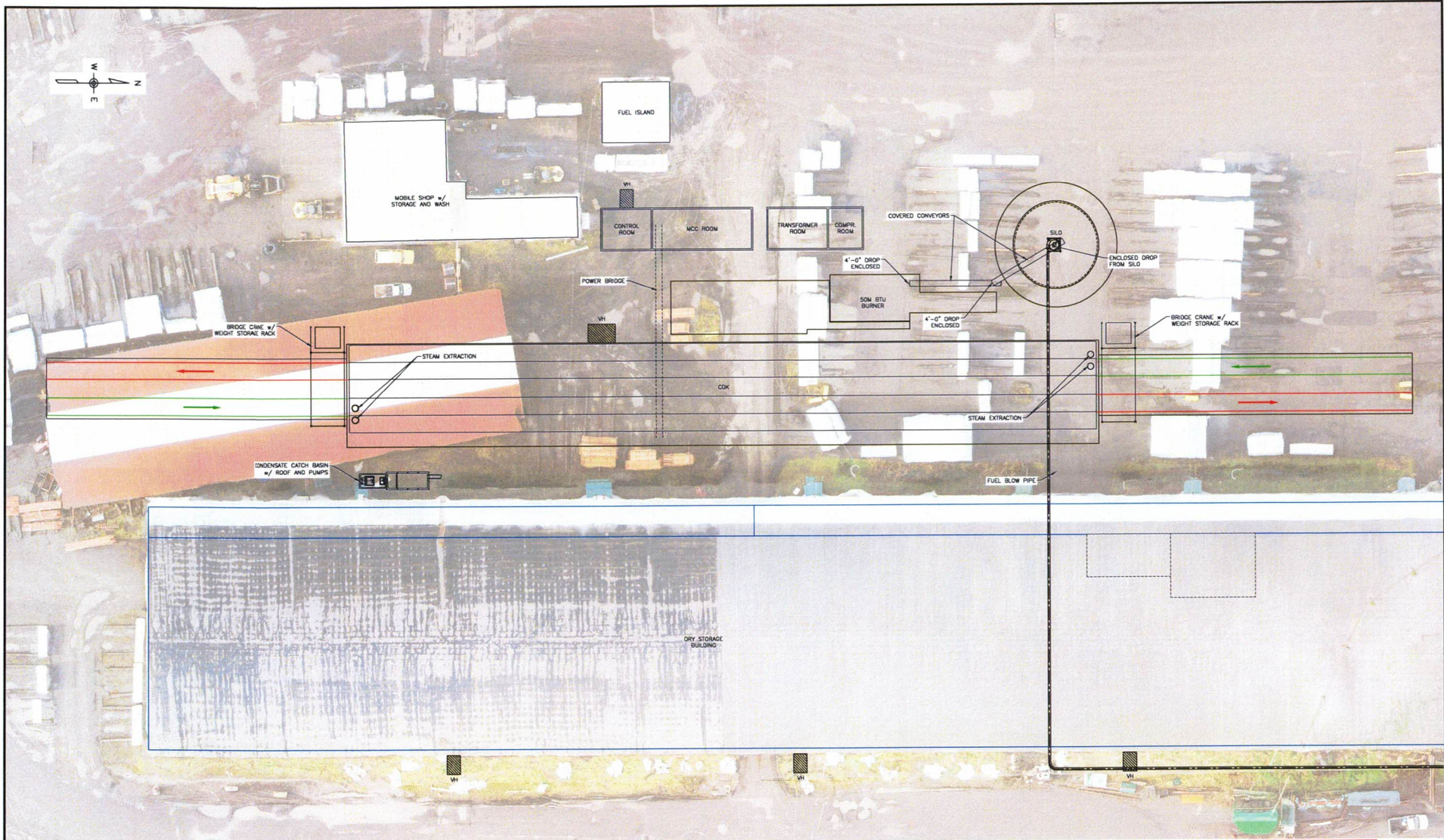

PLAN
SCALE: 1"=20'-0"

PRELIMINARY
NOT FOR CONSTRUCTION
Date: 06-21-2023

THESE PLANS AND SPECIFICATIONS, AND THE ENGINEERING AND DESIGN WORK TO WHICH THEY PERTAIN, ARE HEREBY SOLELY FOR THE PROPOSED PROJECT. CROW DESIGN SHALL DISCLAIM ALL LIABILITY IN THESE PLANS AND SPECIFICATIONS, OR THE DESIGN, AND ANY AND ALL CONSTRUCTION ACCIDENTS THEREIN, ARE, USED OR ANY RELIANCE ON ANY LOCATION OTHER THAN THIS DRAWING IS THE PROPERTY OF CROW DESIGN, P.L.L.C. IT IS LENT AND IS TO BE RETURNED UPON REQUEST. THE DESIGN AND DESIGN DEVELOPMENT ARE THE PROPERTY OF CROW DESIGN, P.L.L.C. AND SHALL NOT BE REPRODUCED, COPIED, OR COPIES IN WHOLE OR IN PART, WITHOUT WRITTEN PERMISSION. COPYRIGHT 2023 BY CROW DESIGN, P.L.L.C. ALL RIGHTS RESERVED.

THESE DRAWINGS DO NOT SHOW THE PRESENCE, LOCATION, POSITION, OR APPLICATION OF SAFETY DEVICES UPON OR NEARBY THE PROPOSED PROJECT AND THE CONTRACTOR IS TO BE THE SOLE RESPONSIBILITY OF THE GENERAL MANUFACTURER AND/OR INSTALLER OF THE PROPOSED SAFETY DEVICES UPON OR NEARBY THE PROPOSED PROJECT. ANY EQUIPMENT AND/OR SAFETY DEVICES UPON OR NEARBY THE PROPOSED PROJECT ARE THE PROPERTY OF THE MANUFACTURER AND/OR INSTALLER AND THE CONTRACTOR SHALL PROVIDE ALL MATERIALS AND EQUIPMENT NECESSARY TO PREPARE THE STRUCTURE, WHETHER ANY OTHER PRODUCT AND PROPERTY DURING CONSTRUCTION. THE CONTRACTOR IS RESPONSIBLE FOR THE OBSERVANCE OF ALL FEDERAL, STATE, AND LOCAL SAFETY REGULATIONS DURING CONSTRUCTION.

REV.	DATE	DESCRIPTION	BY	REV.	DATE	DESCRIPTION	BY
A	06/14/23	RELOCATED/ADDED STEAM EXTRACTION STACKS	SAC				

THE PROFESSIONAL ENGINEER'S SEAL APPEARING ON THIS DRAWING APPLIES ONLY TO THE WORK AS SHOWN ON THIS DRAWING FOR THE ORIGINAL TITLE BLOCK DESIGNATION. ANY ALTERATION OR REUSE OF THIS DRAWING WITHOUT THE WRITTEN CONSENT OF THE ENGINEER IS PROHIBITED.



9923 SW Nimbus Ave. Suite 110
Beaverton, OR 97008-7592
crowengineering.com

CIVIL
STRUCTURAL
MECHANICAL

p (503) 213-2013
f (503) 213-2018



Raymond, Washington

PLANT MODERNIZATION
CDK
AREA PLAN

PLT: 06/14/2023 2:04:3 PM SAC	20348-20	DRAWN	CHECKED	SCALE	DATE	DRAWING NO.	REV.
SAVE: E:\2023\20348-20 CDK Area Plan\2023\100010-02.dwg 06/21/23 10:58:08 AM		DN		1"=20'-0"	05-31-23	20348-100010-12	A

TOLERANCE TO WEGL SPEC

DIMENSIONS IN MILLIMETRES U.O.S.

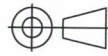

DO NOT SCALE PRINT

IF IN DOUBT - ASK

REV	INT & DATE
B	36" VEM FANS ADDED. STRUCTURE MODIFIED TO DRG. 21419-1-50130-03.
DJW	29/03/2023

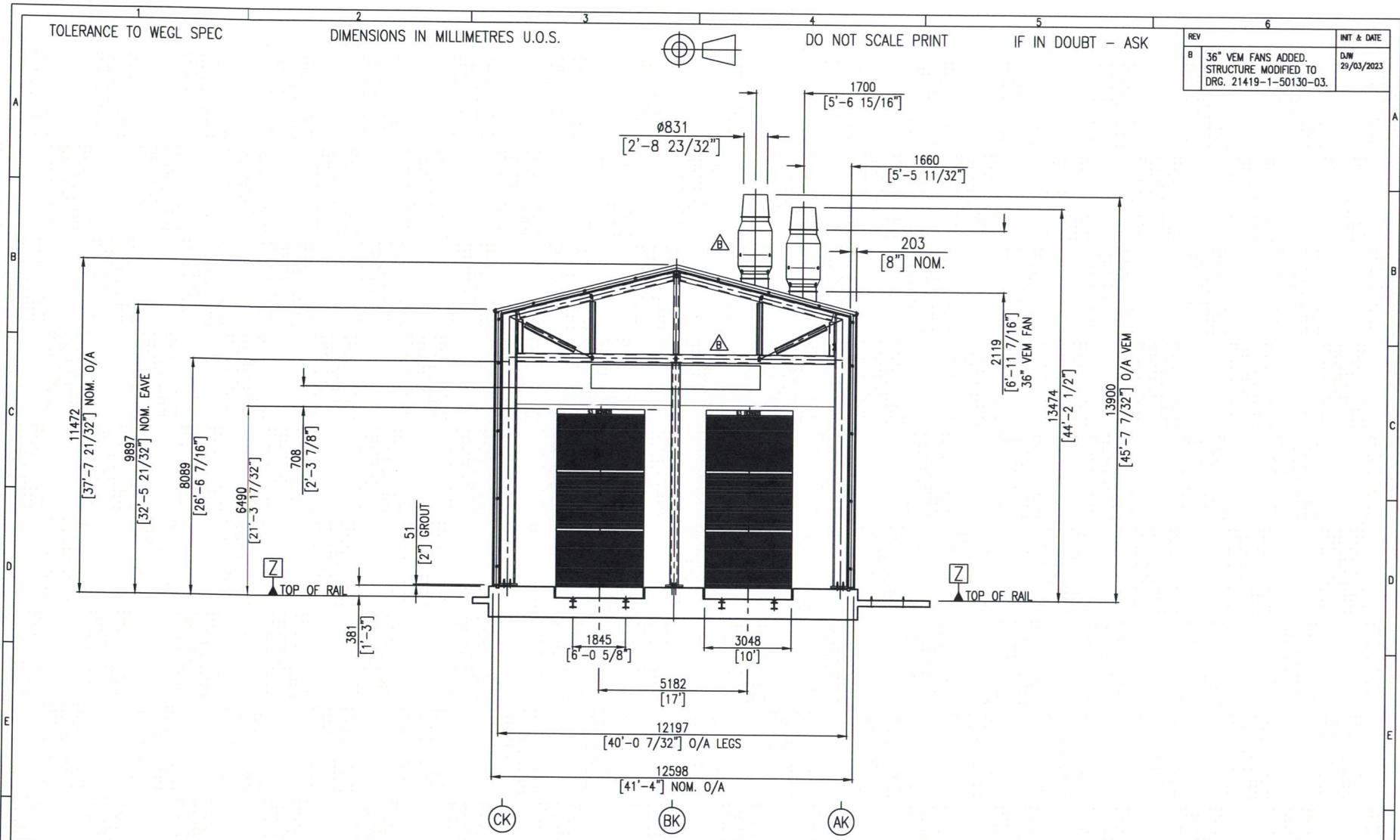

ITEM NO. OR DESCRIPTION OF COMPONENT TO BE MANUFACTURED	MAKE QTY	PACK QTY	MADE BY	CH'KD BY	G.A. DRG. TABLE	GENERATED FROM:	CATEGORY	UPDATE?	TITLE			
					BOM APPROVED	SCALES: 1:125	REFERENCE		RAYMOND WASHINGTON 36" VEM FAN LAYOUT			
					BOM RELEASED	DRAWN JKH DATE 16/12/2022	STATUS CHECKED		FOR KDS QUOTE			
					DXF CHECKED	CHECKED DJP DATE 29/03/2023						
					PAINT/GALV. SPEC	STD APPROVED DATE						
					PACKING LIST							
							JOB: 12630	SUBCODE A	SHEET SIZE: A3	DRAWING NUMBER: A3-12630-910-1	SHT 1 of 1	REVISION B

© 2021 COPYRIGHT NO PART OF THIS DOCUMENT MAY BE REPRODUCED WITHOUT THE WRITTEN PERMISSION OF THE DIRECTORS OF WINDSOR ENGINEERING GROUP LTD. WINDSOR KILNAS PTY LTD.

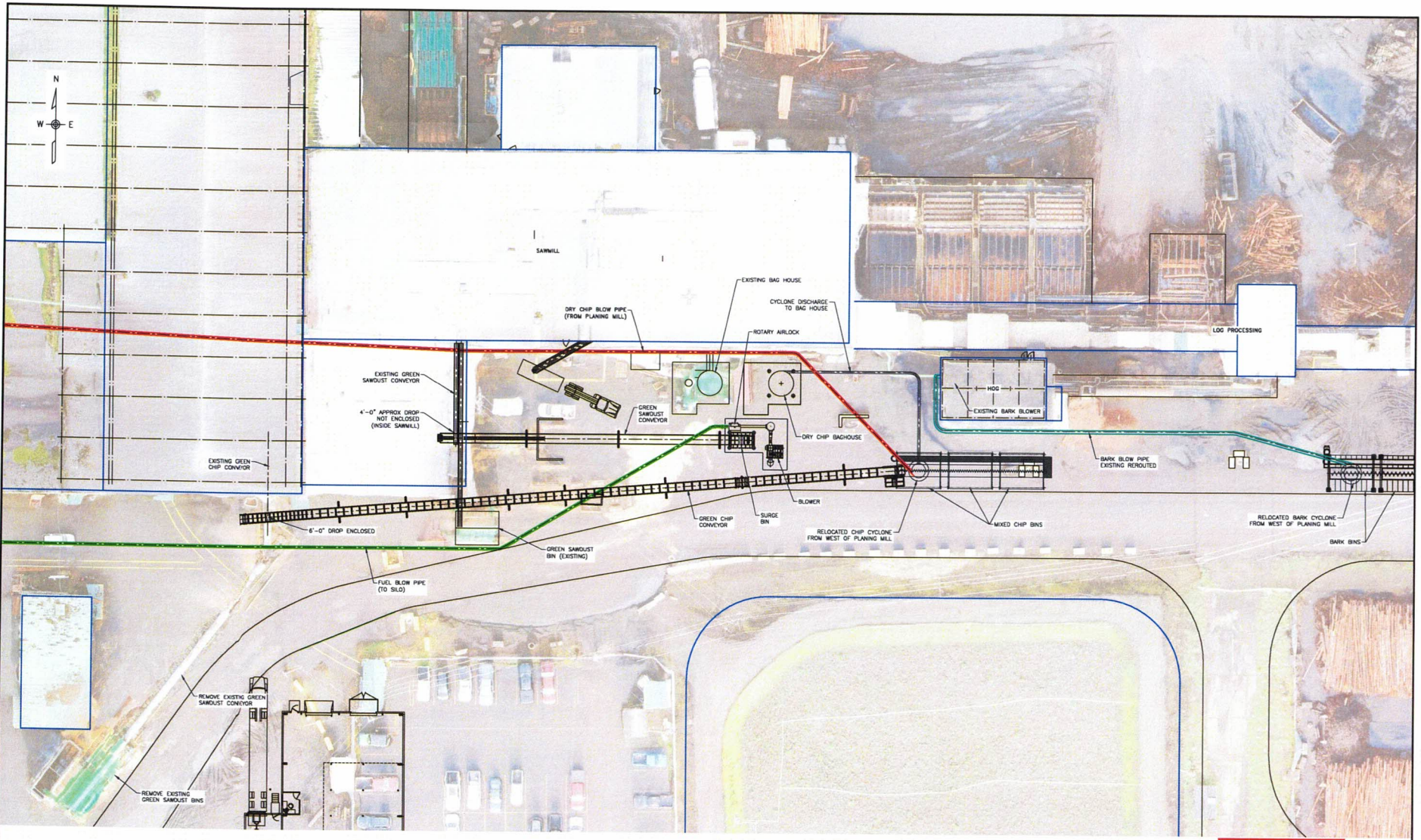

PLAN
SCALE: 1"=20'-0"

PRELIMINARY
NOT FOR CONSTRUCTION
Date: 06-21-2023

THESE PLANS AND SPECIFICATIONS, AND THE ENGINEERING AND DESIGN THEREIN, WHICH FORM PART OF THESE PLANS, ARE INTENDED SOLELY FOR THE PROJECT DESCRIBED HEREIN. OTHER DESIGN, PLANS, SPECIFICATIONS, ALL LABORATORY TEST REPORTS AND INVESTIGATIONS, OR THE PROJECT AND LOCATION IMPROVED HEREIN. THE ENGINEER HAS CONDUCTED VISUAL GENERAL VERIFICATION OF THE PROJECT AND LOCATION IMPROVED HEREIN. THE DRAWING IS THE PROPERTY OF CROW ENGINEERING, P.L.L.C. IT IS LENT AND IS TO BE RETURNED WITHIN THE CONVENIENT AND REASONABLE TIME AFTER THE PROJECT IS COMPLETED. THIS DRAWING, PLAN AND SPECIFICATIONS SHALL NOT BE REPRODUCED, COPIED, OR OTHERWISE USED IN WHOLE OR IN PART, WITHOUT WRITTEN PERMISSION. COPYRIGHT © 2023 BY CROW ENGINEERING, P.L.L.C. ALL RIGHTS RESERVED.

THESE DRAWINGS DO NOT SHOW THE PRESENCE, LOCATION, POSITION, OR APPLICATION OF SAFETY DEVICES UPON OR NEARBY THE PROJECT OR EQUIPMENT. IT IS THE SOLE RESPONSIBILITY OF THE OWNER, MANUFACTURER, INSTALLER, OR USER TO PLACE PROPERLY ALL SAFETY DEVICES UPON OR NEARBY THE PROJECT OR EQUIPMENT AS DIRECTED BY THE MANUFACTURER'S INSTRUCTIONS. THE CONTRACTOR SHALL BE RESPONSIBLE FOR VERIFYING THE PRESENCE, LOCATION, POSITION, OR APPLICATION OF SAFETY DEVICES UPON OR NEARBY THE PROJECT OR EQUIPMENT AS DIRECTED BY THE MANUFACTURER'S INSTRUCTIONS. THE CONTRACTOR SHALL BE RESPONSIBLE FOR VERIFYING THE PRESENCE, LOCATION, POSITION, OR APPLICATION OF SAFETY DEVICES UPON OR NEARBY THE PROJECT OR EQUIPMENT AS DIRECTED BY THE MANUFACTURER'S INSTRUCTIONS. THE CONTRACTOR SHALL BE RESPONSIBLE FOR VERIFYING THE PRESENCE, LOCATION, POSITION, OR APPLICATION OF SAFETY DEVICES UPON OR NEARBY THE PROJECT OR EQUIPMENT AS DIRECTED BY THE MANUFACTURER'S INSTRUCTIONS.

REV.	DATE	DESCRIPTION	BY	REV.	DATE	DESCRIPTION	BY

THE PROFESSIONAL ENGINEER'S SEAL, APPEARING ON THIS DRAWING, APPLIES ONLY TO THE WORK AS SHOWN ON THIS DRAWING FOR THE ORIGINAL TITLE BLOCK DESIGNATION. ANY ALTERATION OR REUSE OF THIS DRAWING WITHOUT THE WRITTEN CONSENT OF THE ENGINEER IS PROHIBITED.



CIVIL
STRUCTURAL
MECHANICAL



PLANT MODERNIZATION
CDK
AREA PLAN

PLOT: 06/21/2023 8:18:47M dm SAVE: I:\2024\2048-20 CDK AREA PLAN\2024-06-21\06-21-2023.dwg	20348-20 DRAWN: DN	CHECKED:	SCALE: 1"=20'-0"	DATE: 05-31-23	DRAWING NO.: 20348-100010-10	REV:
---	-----------------------	----------	------------------	----------------	------------------------------	------

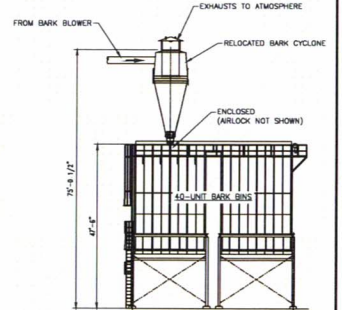
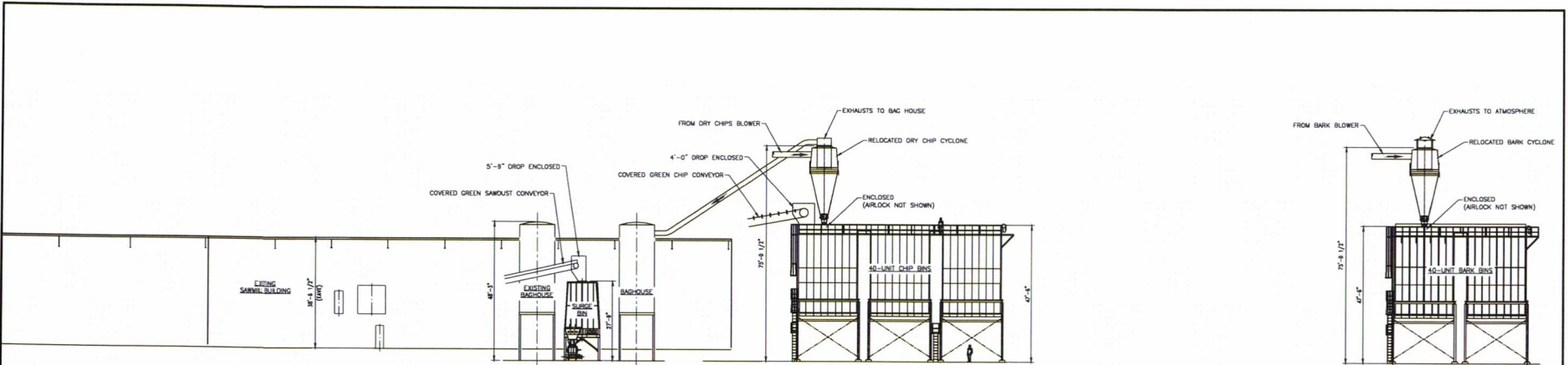

SECTION ①
SCALE: 1/16"=1'-0"

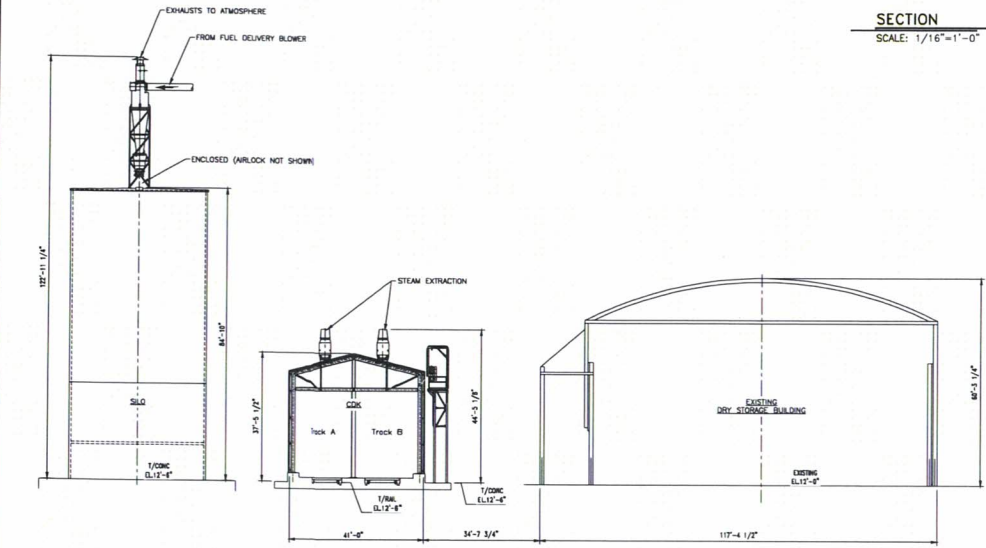

SECTION ②
SCALE: 1/16"=1'-0"



PRELIMINARY
NOT FOR CONSTRUCTION
Date: 06-21-2023

THESE PLANS AND SPECIFICATIONS, AND THE ENGINEERING AND DESIGN WORK TO WHICH THEY PERTAIN, ARE INTENDED SOLELY FOR THE PROJECT DESCRIBED HEREIN. OTHER DESIGN PLANS SPECIFICATIONS ALL LIABILITY OF THESE PLANS AND SPECIFICATIONS, OR THE ENGINEERING AND ARCHITECTURAL SERVICES THEREIN, ARE USED ON ANY PROJECT OR AT ANY LOCATION OTHER THAN THE PROJECT AND LOCATION SPECIFIED HEREIN. THE ENGINEERING AND ARCHITECTURAL SERVICES PROVIDED BY OUR FIRM ARE LIMITED TO THE PROJECT AND LOCATION SPECIFIED HEREIN. IT IS THE RESPONSIBILITY OF THE CLIENT TO OBTAIN ALL NECESSARY PERMITS, LICENSES, AND APPROVALS FROM THE APPROPRIATE AGENCIES AND TO OBTAIN ALL NECESSARY INSURANCE COVERAGE. THE CLIENT SHALL BE RESPONSIBLE FOR OBTAINING ALL NECESSARY PERMITS, LICENSES, AND APPROVALS FROM THE APPROPRIATE AGENCIES AND TO OBTAIN ALL NECESSARY INSURANCE COVERAGE. THE CLIENT SHALL BE RESPONSIBLE FOR OBTAINING ALL NECESSARY PERMITS, LICENSES, AND APPROVALS FROM THE APPROPRIATE AGENCIES AND TO OBTAIN ALL NECESSARY INSURANCE COVERAGE.

REV.	DATE	DESCRIPTION	BY	REV.	DATE	DESCRIPTION	BY

THE PROFESSIONAL ENGINEER'S SEAL APPEARING ON THIS DRAWING APPLIES ONLY TO THE WORK AS SHOWN ON THIS DRAWING FOR THE ORIGINAL TITLE BLOCK DESIGNATION. ANY ALTERATION OR REUSE OF THIS DRAWING WITHOUT THE WRITTEN CONSENT OF THE ENGINEER IS PROHIBITED.



CIVIL
STRUCTURAL
MECHANICAL

Weyerhaeuser
Raymond, Washington

PLANT MODERNIZATION
CDK
SECTIONS

PROJECT: 06/21/2023 5:52:08PM
SAVE: I:\2023\2023-06-21\2023-06-21\2023-06-21\2023-06-21.dwg 06/21/23 10:28:48 AM

20348-20
DRAWN: DN CHECKED: DN SCALE: 1/16"=1'-0" DATE: 05-25-23 DRAWING NO: 20348-100030-02 REV:

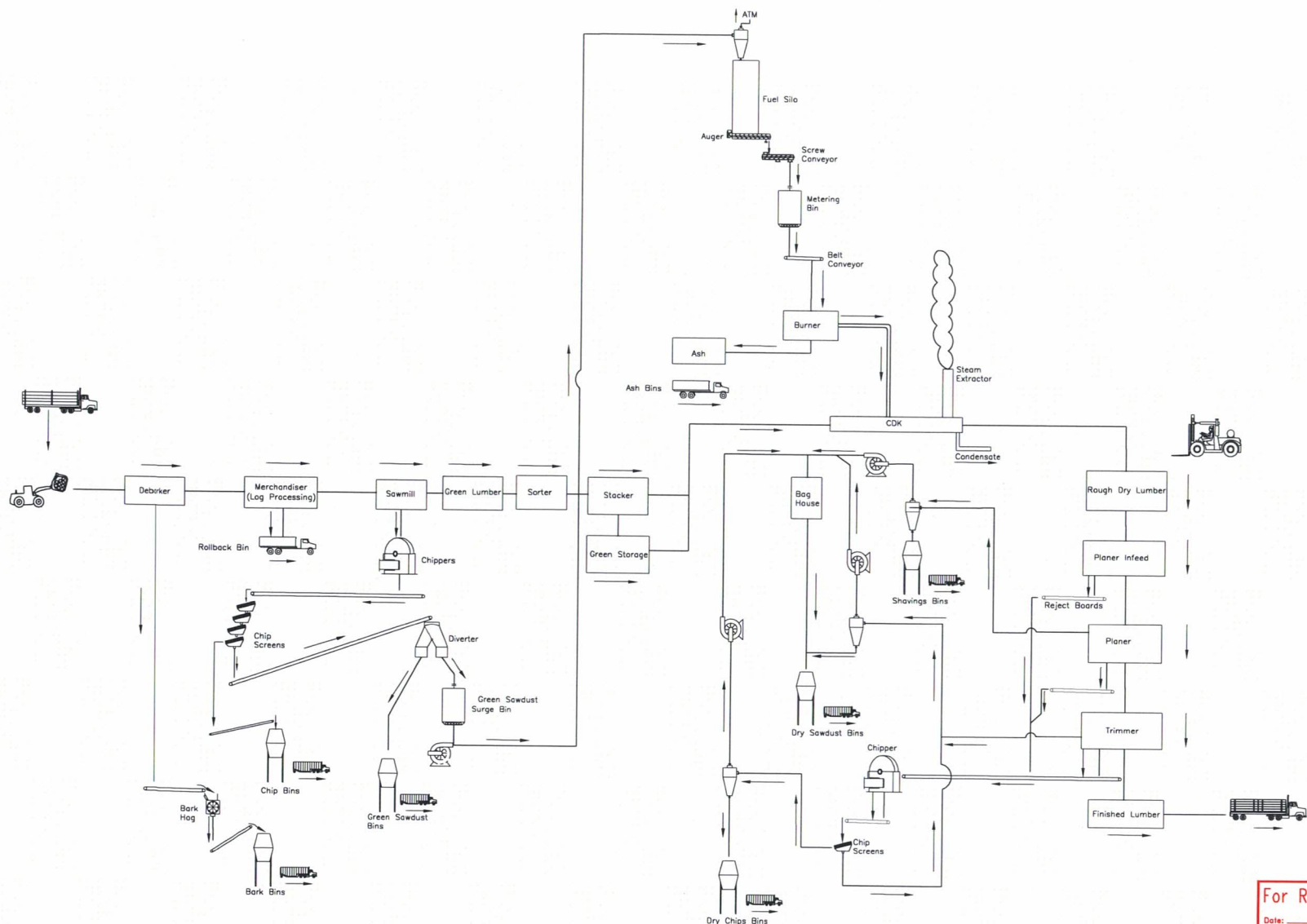

For Reference Only
Date: 01-18-2023

THESE PLANS AND SPECIFICATIONS, AND THE ENGINEERING AND DESIGN WORK TO WHICH THEY PERTAIN, ARE PREPARED SOLELY FOR THE PROJECT AND SPECIFIED AREA. OTHER DESIGN PLANS OCCASIONALLY ARE USED ON ANY PROJECT OR AT ANY LOCATION OTHER THAN THE PROJECT AND LOCATION SPECIFIED HEREIN.
 THESE DRAWINGS ARE THE PROPERTY OF CROW ENGINEERING. IT IS SOLELY AND TO BE REMAINED UNDER LOCK AND KEY. NO PARTS, REPLICAS, COPIES OR DERIVATIVES ARE TO BE MADE OR IN ANY MANNER REPRODUCED, EITHER WHOLLY OR IN PART, WITHOUT WRITTEN PERMISSION. COPYRIGHT © 2023 BY CROW ENGINEERING, LLC. ALL RIGHTS RESERVED.
 THESE DRAWINGS DO NOT SHOW THE PRESENCE, LOCATION, POSITION, OR APPLICATION OF SAFETY DEVICES UPON OR SURROUNDING MACHINERY AND/OR EQUIPMENT. IT IS THE SOLE RESPONSIBILITY OF THE OWNER, MANUFACTURER AND/OR INSTALLER TO PLACE PROPERLY ALL SAFETY DEVICES UPON OR SURROUNDING MACHINERY AND/OR EQUIPMENT AND RELIEVE THE CONTRACTOR FROM THE LIABILITY THEREOF. THE CONTRACTOR SHALL PROVIDE ALL MATERIALS AND EQUIPMENT NECESSARY TO PROTECT THE STRUCTURE, WORKMAN AND OTHER PERSONS AND PROPERTY DURING CONSTRUCTION. THE CONTRACTOR IS RESPONSIBLE FOR THE OBSERVANCE OF ALL FEDERAL, STATE AND LOCAL SAFETY REGULATIONS DURING CONSTRUCTION.

REV.	DATE	DESCRIPTION	BY	REV.	DATE	DESCRIPTION	BY

THE PROFESSIONAL ENGINEER'S SEAL APPEARING ON THIS DRAWING FOR THE ORIGINAL TITLE BLOCK DESIGNATION. ANY ALTERATION OR RELEASE OF THIS DRAWING WITHOUT THE WRITTEN CONSENT OF THE ENGINEER IS PROHIBITED.

CROW ENGINEERING CIVIL STRUCTURAL MECHANICAL
 9925 SW Nimbus Ave., Suite 110
 Bellevue, WA 98008-7932
 P (206) 213-2015
 F (206) 213-2016
 crowengineering.com

Weyerhaeuser
 Raymond, Washington

PLANT MODERNIZATION PROCESS FLOW DIAGRAM

PLT: 01/10/2023 51041M AM	20348-20	DRAWN	CHECKED	SCALE	DATE	DRAWING NO.	REV.
SAVE: SMC DATE		ASM		NONE	1/10/23	20348-60060-01	

APPENDIX C. EQUIPMENT SPECIFICATIONS



234 Industrial Drive
Hendersonville,
NC 28739, USA
Tel: 800 274 5456
Tel: 828 891 8115
Fax: 828 891 5451
www.kdskilns.com

Date: July 28, 2022

Ref: Q22-CDK-0107-A

Weyerhaeuser Company
1740, 51 Ellis St
Raymond, WA 98577

Attention: Mike Stimson, Nick Brooks

Re: KDS Windsor CDK

Dear Mike & Nick:

We would like to submit our proposal for the supply of one new high capacity CDK-351 system including burner, silo, vapor extract modules and controls. This system's designed drying capacity rate is 310MM bdf/yr per CDK of 2" Douglas Fir @ 93 layers. All this equipment on offer represents the cutting edge of this technology. We are confident that we will exceed your expectations and you will have the highest performance direct fired CDK system currently possible.

KDS Windsor Offer:

We are offering the supply, delivery and installation of one **KDS Windsor HC-CDK-351 system** including green sawdust gasification burner systems with DrySpec® and DryTrack® CDK controls systems.

System design:

- The target final MC is 15%
- The heat plant will use a KDS Windsor 50MM btu/hr green sawdust gasifier per CDK

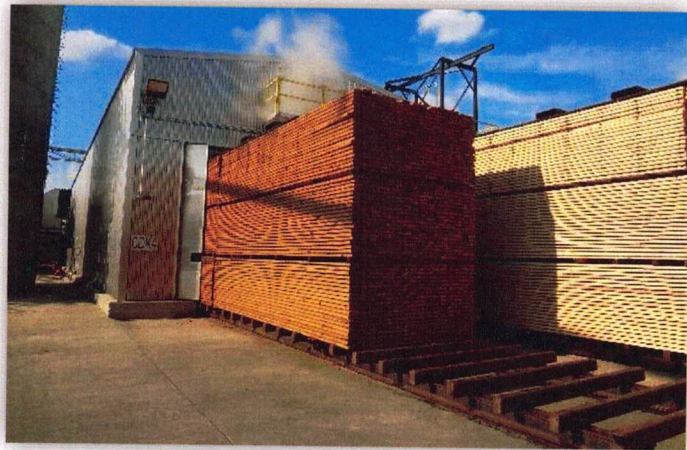

Pricing And Commercial Items:

CDK Items:	Cost
One HC-CDK-351 system with 50MM green sawdust gasifier	[REDACTED]
Mechanical installation	[REDACTED]
Freight to site	[REDACTED]
DrySpec® and DryTrack® CDK controls	[REDACTED]
Stainless Steel Fan Tubes in ER Chambers	[REDACTED]
316 Stainless Steel upgrade in ER Chambers	[REDACTED]
Drawings for carts and weights	[REDACTED]
Drag chain hopper	[REDACTED]
Four extra refractory duct sections	[REDACTED]
Extended incline screw	[REDACTED]
Vapor Extraction Modules	[REDACTED]
Extra RTD's	[REDACTED]
One 40' x 84' silos with unloaders	[REDACTED]
Halo system	[REDACTED]
Total with all options	[REDACTED]

[REDACTED]

Key Features Of The KDS Windsor Offer:

- Robust CDK chambers with tray and cladding design that create a unique ventilated housing.
- Fully baffled plenum dividers in the energy recovery (ER) sections giving 3 zones per ER chamber to provide industry leading conditioning, MC standard deviation and fuel efficiency.
- Kiln duty fiber brush horizontal baffles along the top of each stack.
- Fully customized DrySpec® CDK controls including all operational, safety, comprehensive alarm features and fully automatic push rate control from startup to shut down.
- DryTrack® CDK MC System on each track giving real-time, MC readings that are used to automatically adjust the push rate to achieve a desired final MC target with low standard deviation and high-grade recovery.
- Catwalk with stair access the entire length of the CDK.
- Green sawdust gasifier system that is cleanest burning and highest heat output in the industry.
- Decades of experience designing drying systems with both direct and indirect heating systems.

KDS Windsor CDK Design Principles:

The KDS Windsor CDK system has a reverse flow double track design and incorporates preheating, drying, cooling, equalizing and conditioning phases all in one extended chamber. The lumber stacks traverse through the kiln in opposite directions on the two tracks. The lumber is automatically advanced, based on temperature, time and with the DryTrack CDK option, the moisture content of the lumber in the MD (main drying) section by the pusher units.

The KDS Windsor Fresh Air Injection provides both dry bulb and wet bulb temperature control. Through controlling optimum wet bulb depression (dry bulb temperature – wet bulb temperature), drying is accomplished using lower temperatures while maximizing production. This method of drying produces the highest quality and aesthetically pleasing dried lumber.



The CDK system control is via our DrySpec® CDK kiln management program integrated with our optional DryTrack® CDK in-kiln moisture measurement system. The KDS Windsor CDK design is capable of using combinations of time, temperature and MC of the lumber exiting the central MD section to control the rate of drying, i.e. the advancement of the lumber stacks. Each track can be controlled independently - this means that you could have different board thicknesses on each track if you wanted.

The DryTrack® CDK system is the only field proven system that can both measure lumber moisture content and control the CDKs push decisions. Simply being able to read a moisture content is only a portion of the drying requirement. Moisture based push control is essential to maximize the drying efficiency, production rate, and quality of the lumber being dried. This KDS Windsor exclusive capability is the result of years of research and development of the proper use of the moisture content data gathered from the drying process. To date, the DryTrack® push control algorithm stands alone in CDK lumber drying technology. Currently, dozens of CDKs are operating successfully using moisture-based push control.

CDK Equipment Description:

KDS Windsor's equipment design is driven in response to the harsh environment created by a continuous high temperature lumber drying process. Our design targets the following CDK specific issues:

- CDKs by design, run continuously and don't dry out inside
- Moving parts need to be serviced while the CDK is running
- Temperatures and air flow need to be consistent in both fan directions for tight standard deviation
- Reliable lumber pushes, push distance accuracy and regular push intervals are required for consistent drying
- Maintaining proper airflow distribution and accurately reading MC with moving lumber
- Reducing the risk of fires in an open environment which cannot be sealed shut

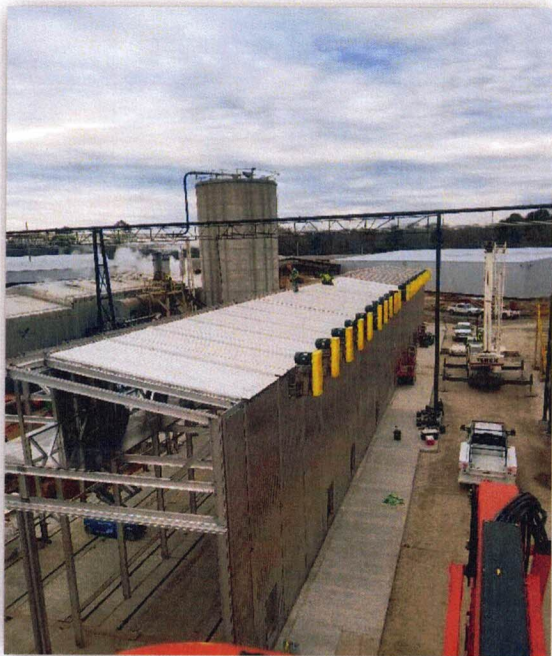

CDK structure and panels

The KDS Windsor CDKs structure is constructed with all aluminum and stainless steel materials including stainless steel footings and fasteners in the MD section and the ER structure is constructed from 316 stainless steel materials. The C-formed inner skins are fabricated from 304 stainless steel in the MD, 316 stainless steel in the ER and the outer cladding is corrugated aluminum. Together these components create our robust, floating, vented, and self-draining CDK housing. Numerous, sealed entry and exit man-doors are provided for access to and emergency egress from every section of the CDK.

Fan wall and motor truss

Material thickness on the fan wall and motor truss will be 3mm with a 12" wide fan orifice. There is also a vertical support leg added under the tube in the motor truss at the propeller end.

CDK fan systems

The KDS Windsor fan systems are designed with low loss Gates Polychain timing belts and sheaves for efficient use of horsepower. The fan system's internal bearings are externally lubricated via pre-assembled, stainless-steel grease lines accessible from the exterior catwalk. Fan shafts utilize SKF spherical bearings. KDS Windsor CDKs use Smithco kiln fans. This proposal includes stainless steel fan assemblies in the ER sections. The MD section fan assemblies are painted steel design.



During commissioning the fan blade angle will be set to achieve the required air flow and heat transfer into the lumber through the sticker openings with optimum electrical efficiency. Precise pitch setting is achieved using a proprietary pitch setting tool developed by Windsor. Fans are all dynamically balanced in the field to minimize vibration and maximize belt life.

Aluminum walkways above the distribution duct provide access to the CDK fans and distribution duct slide gates. Stainless steel handrails offer fall protection along the length of the outer edges of the walkway in both the MD and ER sections.



CDK divider walls and baffling

Each ER is divided into three individual sections to optimize airflow while maximizing energy recovery, equalization and conditioning in each. Section dividers consist of an aluminum and stainless-steel wall through the entire CDK cross-section creating the three separate compartments. The divider walls are baffled horizontally above the lumber stack with kiln duty fiber brush baffle. Divider wall vertical baffling is achieved using spring loaded aluminum baffles. Airflow is directed through the lumber sticker openings using a high temp fiber brush overhead baffle system.

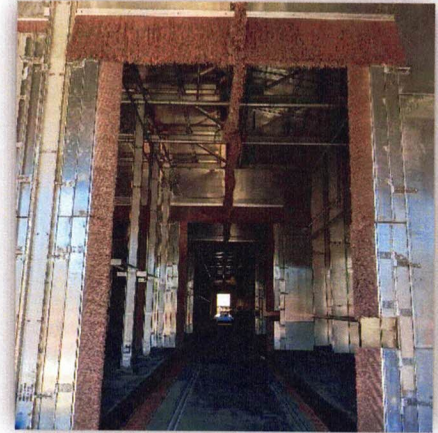

The KDS Windsor baffling system creates unfavorable conditions in the ER chambers for a fire to start. The individual ER sections reduce the amount of available oxygen and create a high humidity environment particularly in the inner ER section immediately following the MD section (it's literally raining in this section). The majority of CDK fires have occurred as the lumber exits the MD section. The KDS Windsor design has never experienced a CDK fire during normal operation.



Distribution ducts and downcomers

The heat downcomers between tracks in the MD sections are designed to reheat the kiln air as it exits the first track prior to entering the second track of lumber. These downcomers have been designed to be highly aerodynamic for enhanced airflow with minimal disruption compared to diamond-shaped downcomers. To evenly distribute airflow through the slots an 8' divider sheet has been added to the top half of the downcomers.

Each downcomer is provided with a ground level manual adjustment for balancing the air volume equally throughout the main drying chamber. Ground level damper controls make it safer to adjust air flow by eliminating the need for ladders or lifting equipment. The downcomers will be adjusted and set during commissioning.

All distribution ducts are designed and built to insure uniform air distribution throughout the MD chamber. Distribution ducts are constructed from heavy gauge, painted steel.

Hydraulic pusher units

Each KDS Windsor CDK includes a hydraulic pusher system on each track just outside the green lumber point of entry. Pusher systems use Parker hydraulic pumps and cylinders for advancement of the lumber and an MTS Temposonic linear distance transducer for accurate positioning. Greaseable steel "dogs" with counterweights contact the kiln cart cross member to advance the load. Pusher frames and foundations are designed to eliminate reactive up lifting forces from pushing up on the lumber carts. The pusher will have the ability to fold down the cart arms when in the fully retracted.

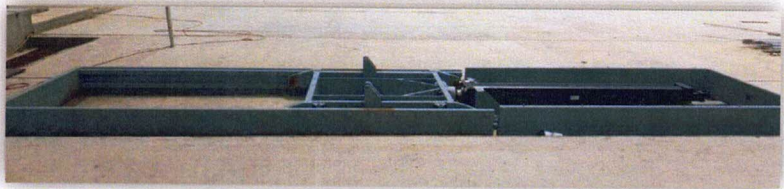

CDK controls

Operator controls are customized by our programmers to meet the needs of the site. During commissioning, alarm needs and configurations, site layouts, geographic orientation and site-specific equipment such as wood fuel delivery systems are integrated into the HMI and PLC systems. Additional equipment controls, custom reporting and SQL data exchange can be added if desired and will be discussed and agreed upon prior to commissioning.

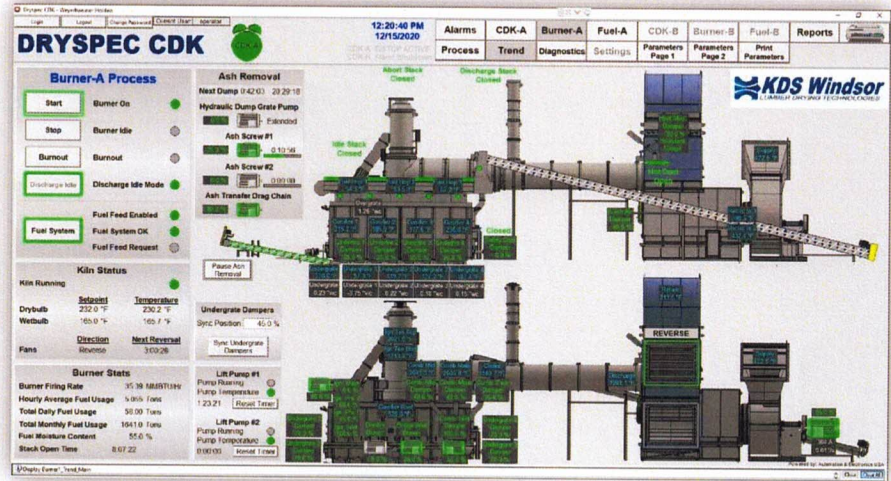

KDS Windsor CDK controls use all commercially available Allen-Bradley components and software. Being the leader in USA control systems, Allen-Bradley components and support are readily available if needed. CDK PLC systems utilize the ControlLogix platform with Logix 5000 software and the PLC programming software version can be matched to site preference. The site customized HMI will be built using Allen-Bradley Factory Talk software.

Each CDK includes a NUC PC the included PC has no moving parts and does not require forced air to keep the power supply cooled. Considering the dirty mill environment, the all solid state, fan-less design improves longevity.

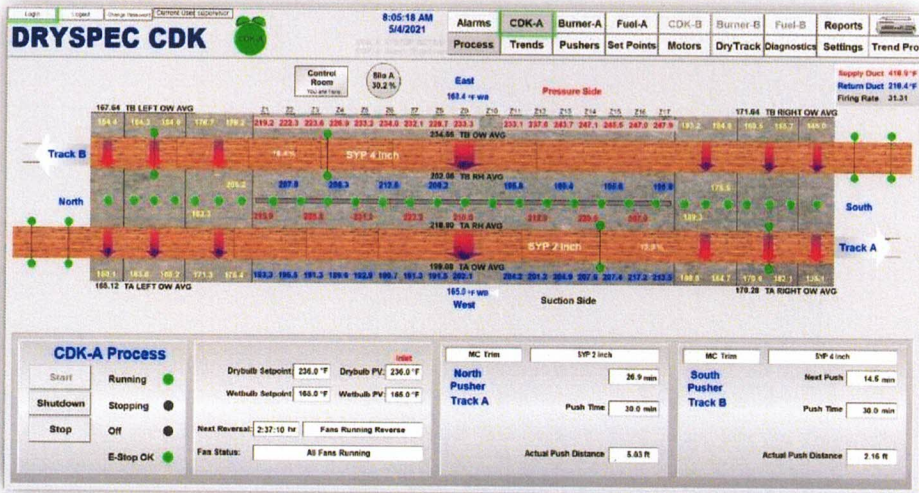

Accurate temperature measurements are critical to the lumber drying process. All CDK temperature sensors will be industrial self-diagnosing RTD's. Each RTD sensor is fitted into a mineral insulated metal sheath (stainless steel 1/4" OD) to provide a robust and impact resistant fitting. All RTD leads are protected with armored cable and high

temperature insulation. All terminations and connections are external to the CDK in aluminum terminal heads. RTD's are engineered to be placed in specific areas throughout the CDK. Reheat sensors are installed in refractory lined heat shields to reduce radiant heat influences and provide true entering and exiting air temperatures.

DryTrack® CDK

The DryTrack® CDK system consists of 4 sensor assemblies and 2 DryTrack® meter cards per track. Sensors are located at each dry end of the MD section to read the lumber M.C. as it exits the drying section. Painted steel sensor arms and supports are rigidly mounted to the CDK structure. During operation, sensor arms are raised into position to contact stainless steel plates inserted by the operator at designated sticker openings. Prior to pushing, arms are lowered to clear any protruding sticks or boards.

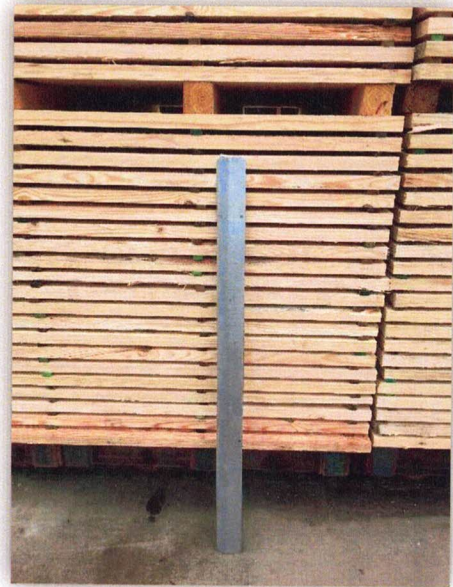

Arms are raised and lowered using pneumatic cylinders located outside the kiln wall. Through wall penetrations are used to pass the stainless-steel lifting cable that connects the pneumatic cylinder to the sensor arm. An additional insulated wall penetration is used to connect the meter card to the sensor. All electronics are located outside the kiln keeping them out of the harsh CDK environment. Meter card enclosures are kept under positive air

pressure to keep contaminants out and allows KDS Windsor to offer a 3-year replacement warranty on all meter cards.

Vapor extraction unit

Extraction modules at each end of the CDK are designed to reduce ground level water vapor by pulling the vapor through a powered stack and projecting it up away from the end of the CDK. Extraction units use a bifurcated fan with a variable speed motor. The 4' long, all aluminum and stainless-steel units are attached to each end of the CDK. Vapor extraction units will pull the majority of the water vapor that normally exits the end doors up high into the atmosphere to avoid the potential fog hazard in loading area.

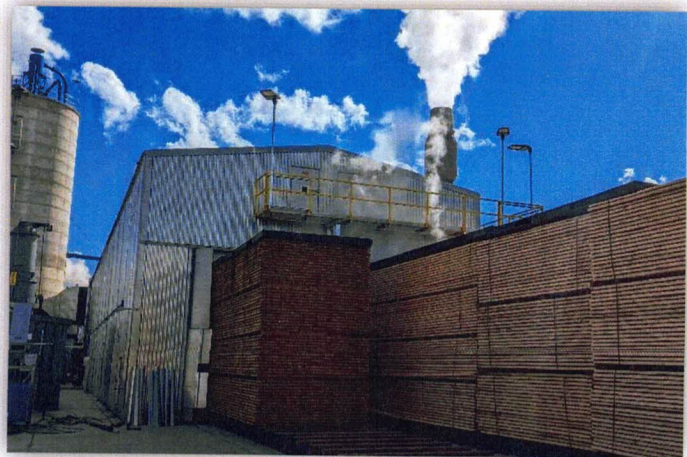

KDS Windsor Green Sawdust Gasification Burner System:

The KDS green sawdust gasification burner system generates combustible gases from green sawdust. The combustible gases are transferred through the ignition tee to begin the combustion process. Secondary gas burners individually manage inlet air for complete and clean combustion. The clean heated air is pulled through a large mixing chamber and combined with both return air from the CDK and outside air then forced into the CDK through a large recirculation blower for process heat.

The KDS Windsor green sawdust gasification burner system is the most sophisticated and highly automatically controlled burner available. Numerous temperatures and air pressures are monitored to trigger alarms and shutdowns if necessary. Automatic control is achieved through more than a dozen points of adjustment to shape the temperature profile from gasification to clean, complete combustion. Accurate temperature control is the result of combinations of variable speed blowers, proportioning inlet vane



dampers and electro-pneumatically controlled butterfly dampers. Multiple PID and cascading control loops automatically maintain temperatures to deliver consistent heat and the cleanest dried lumber. Advanced control loops and an intuitive operator interface reduces the time required for site personnel to monitor the burner system and minimizes the need for adjustments.

The KDS Windsor burner system is the product of years of research and field experience transitioning from using green sawdust to heat batch kilns to the unique requirements of heating CDKs. Our design has proven to meet or exceed its rated output allowing us to offer the highest production guarantees available.

The heat plant included with the proposed CDK is a KDS Windsor green sawdust gasification burner system. The burner system is comprised of highly-engineered and robust components including:

- Unique dual stack design for safety and ease of use.
- Multiple under-grate air inlets for even air distribution as it enters the pile.
- American made, CNC machined cast iron grates.
- Unique bridgeway with pile management air system.
- Factory poured and cured refractory lined green sawdust gasification chamber.
- Factory poured and cured refractory tee and burner abort stack assembly with sleeved intake for pre-heat of gas combustion air and failsafe shutdown.
- Secondary gas burner system with 3 individual burner chambers.
- Factory poured and cured refractory hot duct sections between burner chambers and the mixing chamber.
- Factory poured and cured refractory lined discharge stack for keeping combustion ducts hot during idle periods for quick burner system re-starts.

Wood fuel moisture monitoring system

We have included our proprietary, real time, automatic wood fuel moisture content measuring system which will continuously measure the MC of the fuel as it is delivered to the burner. The fuel monitoring system provides the operators real-time values of the incoming fuel MC through the Dryspec® CDK HMI control screens. Fuel MC data is monitored and recorded with historical, configurable trends.

Note: If wood fuel moisture content is beyond the maximum allowable rating for the system, the heat value of the fuel is reduced and the BTU output of the burner and burner performance will be affected, including how clean it will burn. Wet fuel will negatively affect the CDK push rate.

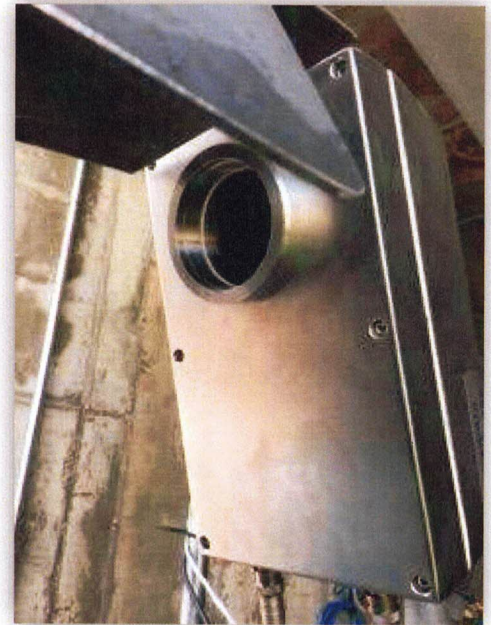

Grate frame supports

Each gasifier is provided with 6" x 4" x 1/4" interior grate frames and 6" x 2" x 1/4" perimeter frames. The frames are all welded construction and provide the cast iron grate support. The lower shaker grate bearings are bolted to this frame.

Grates

Each gasifier is provided with 6" wide x 41-1/2" long cast iron pinhole grates. The grates have 1/4" diameter reverse taper holes to provide efficient wood gasification and self-cleaning properties. All grate holes are CNC machined for accuracy, rather than cast into the piece. All grates are made in the U.S.A.

KDS Fuel Tracker MC ®

Grate shaker

Each gasifier is provided with 6" wide x 41-1/2" long shaker grates complete with cast iron bearings. The grate shaking mechanism is comprised of a 2-1/2" diameter Sch. 80 pipe shaft and 3" diameter pipe sleeves complete with steel linkages and tie bars. Each end of the shaft is connected to a hydraulic cylinder. Two automatic limit switches are provided for timing the position of the shaker system.

Gasifier walls

Gasifier walls are fabricated from 1/4" thick plate framed with 4" x 3/8" steel angles. The wall sections are a maximum of 8'-0" wide x 11'-3" high. All sections are factory poured utilizing a dense, high temperature refractory over a lightweight insulating refractory. Stainless steel refractory anchors are provided at 12" centers on the walls for anchoring the refractory. The wall sections are shipped as cast sections and field-bolted with a trowelable plastic refractory between sections. All required service access doors and observation windows are factory installed.



Gasifier roof

Each gasifier roof is fabricated into three sections with a maximum width of each section 7'-0 1/2" wide. They are fabricated out of 1/4" thick steel and stiffened with structural channels. The roof has stainless steel "V" anchors factory welded on 9" centers for the refractory attachment. The dense, high temperature refractory is poured over a lightweight insulating refractory. The fuel hopper and gas outlet openings are factory cast into the roof. A set of stairs and catwalk will be provided for external access to the roof of the burner.

Note: All stainless steel wall and roof anchors are 3/8" diameter, single piece formed and twisted rod which are bent in a U-shape for welding to the burner steel. This allows for approximately 2" of weld on the inside and 3" of weld on the outside of the bend, substantially stronger than stud welding only. The weld is critical to minimize the possibility of roof refractory collapses.

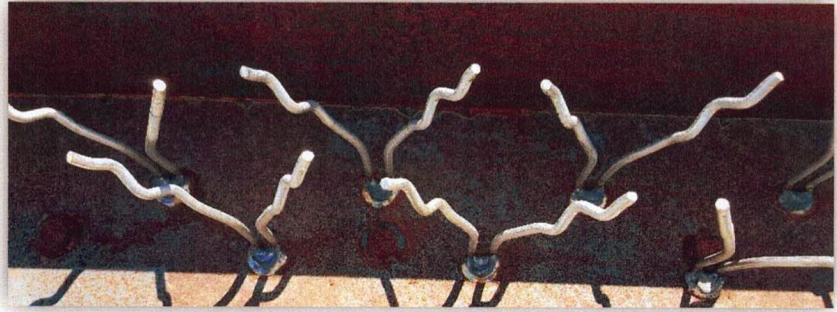

Automatic idle control air actuation system

The burner is provided with our innovative automatic idle control air system with safety blowback shield. Designed with operator safety in mind, this system will automatically open the side door during a shutdown to allow the burner to enter a controlled idle mode and eliminates the requirement for operators to intervene. The door opening can be adjusted from the operator screen as more or less air is desired to control idle temperatures.

Gasifier internal bridgewall design

A 23" thick poured refractory wall section is located approximately 4'-0" from the rear wall where the observation window is located. This wall separates the sawdust section from the rear of the burner wall nearly doubling the gas volume in the gasifier section above the grates versus systems without a bridgewall. This additional volume provides longer gas retention time and produces cleaner hot gasses exiting the chamber and entering the kiln recirculation air system due to the increased distance of the fuel to the suction point.



The bridgewall forced air system is also included with an air injection blower system to stoke the fuel bed above the shaker grates to maintain pile thickness. An additional water pit and second ash screw are provided to minimize ash carry over into the kiln, creating cleaner lumber.

Primary ignition section

A refractory lined ignition section is on top of each primary gasifier chamber and is provided with its own blower.

Gas ignition begins in this section and the burning gas is delivered to 3 individual gas burner sections. The inlet of the ignition section is elongated to lower the suction on the fuel bed and minimize any carry over into the CDK.

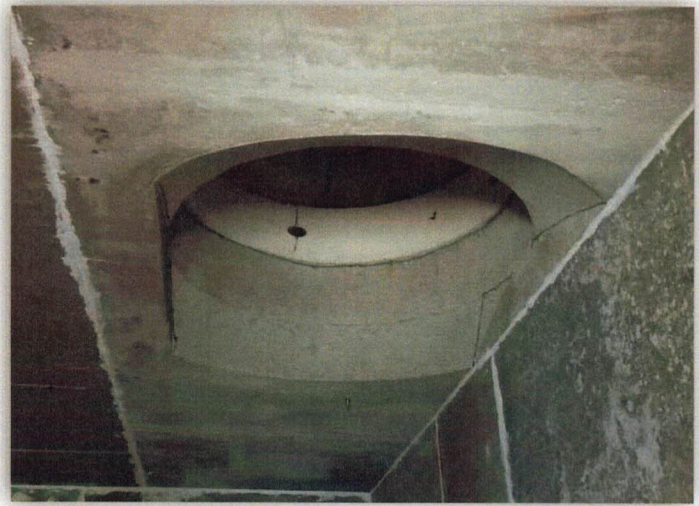

Secondary gas furnace

A refractory lined, three section secondary gas burner is provided complete with factory installed combustion air tuyeres. The secondary gas burner is installed at the outlet of the refractory tee. A separate blower provides combustion air to the three secondary gas burner sections. At the exit of the burner section is the refractory lined choke. The outlet of the choke is connected to the refractory lined hot duct.

Refractory duct

Each gasifier is provided with a straight refractory lined duct and elbow which connects from the secondary duct to the reheat mixing chamber. A structural steel frame will be provided to support the refractory ductwork to keep the weight of the ductwork off the mixing chamber.

Additional refractory duct sections (option)

We will add 4 extra hot duct sections, without air injection, to give an approximate 30' distance from choke to discharge to allow for longer retention time and more thorough combustion. This will also extend the fuel incline screw approximately 20'.

Under-fire air

Multiple under-grate inlet dampers are provided complete with proportional pneumatic actuation to evenly distribute the under-fire air for a uniform formation of gases (pyrolysis) from the fuel bed.



Ash removal screw

Each gasifier is equipped with 2 automatic ash removal screws that are operated with an adjustable timer that allows the frequency and duration of the ash removal to be set by the operator. Each ash removal screw is 9" diameter, full pitch, running in a tubular trough (in each of the two ash pits). The screws are driven by shaft mounted reducers complete with 3 HP TEFC motors and belt drives. The screws and tube liners are high grade AR400 steel for longer service life. Both ash screws dump into a 3HP transfer screw to deliver the removed ash to the customer supplied bin.

Hydraulic system

A 3 HP hydraulic unit is provided to operate the shaker system. The unit is provided with a solenoid valve to automatically shift the direction of the shaker grates. Two 3" diameter x 4" stroke hydraulic cylinders are provided, complete with hoses and piping.

Abort stack

The abort stack system sits atop the refractory duct above the gasifier. The system is designed with fail-safe counterweights and automatically opens if power to the gasifier is lost or in case of alarm controlled burner shutdowns. This stack provides the safety failsafe by pulling the hot air away from the kiln when triggered in an alarm condition.

Fuel hopper with chain drive

The all-welded steel fuel hopper is complete with 3/8" thick plate construction and 3/8" x 3" bar stiffeners on 24" centers. The bottom flange is 1/2" x 4" wide bar. A high temperature gasket tape and silicone seals the fuel hopper to the gasifier.

The fuel hopper is topped with a fuel drag chain system to level the fuel in the hopper while automatically filling in any holes in the pile. The hopper is provided with vibration type fuel level switches for operating the leveling chain. This provides controlled switching of the fuel delivery to the gasifier fuel hopper. It will also have K type thermocouples to monitor temperatures for safety shut down on fuel loss.



Inclined screw conveyor

Fuel is delivered to the fuel hopper via a 14" diameter inclined screw conveyor that is provided with a half pitch screw and all required hanger bearings. The shafts are 2-7/16" diameter with 5/8" diameter hardened bolts. The conveyor is provided with a TEFC motor and shaft mount reducer. The conveyor is sized to deliver the required tonnage of green sawdust.

Recirculation air system

A high-volume mixing chamber designed from computer modeling thoroughly mixes combustion, return and fresh air prior to delivery into the CDK. The chamber sizing is aerodynamically matched to the air volume created by the recirculation blower. The chamber joins the recirculation blower to the burner and to the CDK using our patented dual return air system. The mixing chamber is insulated with high temperature insulation and sheathed in aluminum.

Installed in the mixing chamber, a refractory lined, double hinged isolation damper separates the hot duct from the recirculation system during idle, shutdown and in alarm conditions. The damper includes a failsafe design that closes when power or air is lost. The mixing chamber is designed to allow the isolation damper to be moved completely out of

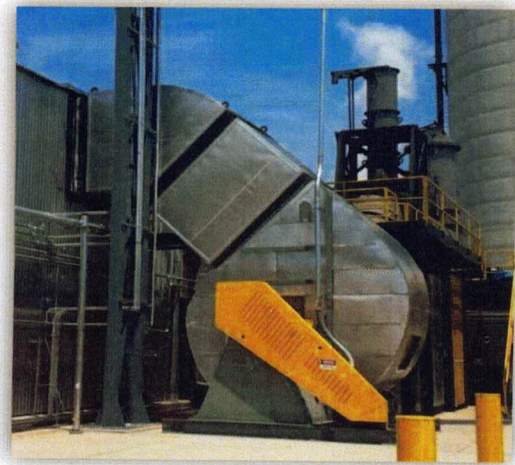

the airstream to maximize recirculation air flow. Site ports are installed in the walls of the mixing chamber for visual inspection of the burner output.

A high-performance, Class 3 recirculation air blower system specified by computer modelling for proper air flow at designed static pressure provides the required recirculation air for the CDK.

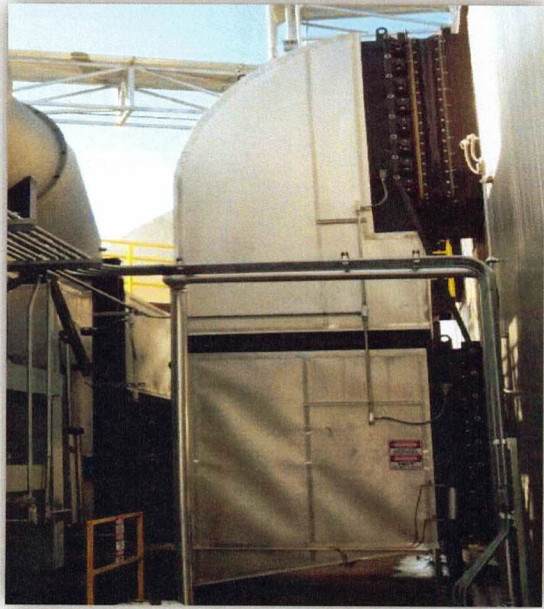

The blower motor is sized for operation with a VFD to allow for cold start-up without upsizing the motor. The blower housing is also insulated and sheathed like the mixing chamber. A large supply duct delivers air from the recirculation blower into the overhead heat distribution duct. The distribution duct uniformly delivers hot air throughout the CDK using overhead slide gates and aerodynamic reheat air downcomers.

Our patented dual return air duct system brings exiting air into the mixing chamber where it is blended with burner and fresh air. The dual return system uses control dampers to select between wall mounted and overhead ducts to return only exiting air from the CDK. The duct and damper system evens the pressure between fan directions allowing the CDK and burner to run at optimum operating levels at all times. Utilization of the dual return system provides uniform heating and maximizes burner output resulting in the highest possible lumber production.

On-Site Work And Support:

Commissioning

KDS Windsor engineers will attend site for up to 3 weeks to test and commission the CDK and burner to ensure it is working to the specified performance criteria. During this period our engineers will provide basic training for your operators of the equipment. Your operators and maintenance staff will need to make themselves available during this training period. The main focus will be to ensure that staff understands how to operate the equipment safely and efficiently.

On-site training will include:

- Starting - Stopping the equipment.
- Selecting and creating different schedules.
- Modifying existing and running schedules.
- Controlling the rate of advancement.
- System safety procedures for safe operation of the burner and CDK chamber.
- Trouble shooting procedures.
- CDK chamber and burner preventative maintenance planning.

Handover and completion

After commissioning is complete and our engineer has verified the equipment functions to its designed specification, the equipment will be handed over for commercial operation and the practical completion certificate signed. Minor re-work and items to complete which do not affect the safety or commercial operation of the plant will not be grounds for not signing the practical completion certificate. Provisional manuals will be available with final copies of the manuals and as-built drawings being available within 4 weeks.



CDK structure design

The CDK structure is designed and certified to ASCE 7-16 safety factor 1 with an importance factor of 1.0. Should your insurer require an alternative Category and importance factor there may be additional costs and delivery delays.

Mechanical guarantees

All mechanical equipment supplied by KDS Windsor is covered by a 12-month replacement part guarantee. The guarantee does not cover accidental impact damage, the corrosion caused by drying of CCA or ACQ treated timber or periodic replacement of items such as door seals which are occasionally subject to mechanical damage, but easily replaced, and is conditional on the chambers being used and maintained normally and correctly in accordance with the operation and maintenance instructions. We will pass on suppliers' guarantees (normally 12 months) on all purchased items.

The burner refractory lining is warranted for a period of six months commencing at start-up. Repairs are prorated from date of start-up and will be repaired or replaced after authorization and verification by a representative of KDS.

Control hardware guarantee

DrySpec®/DryTrack® PLC/PC hardware is guaranteed for 12 months only if power to them is supplied from the included uninterrupted power supply (UPS). The UPS will provide clean, regulated power to PLC and computer systems, thus protecting the systems from power surges and spikes. We cannot provide any guarantee on control or moisture content hardware components if the UPS is not in use. DryTrack® moisture measurement cards are guaranteed for 3 years.

Software

Remote support is provided for six months from the date of commissioning for all DrySpec® software systems. This support is via phone or network connection provided that dedicated, direct external phone line or an Ethernet network connection via VPN is made available. Remote support cannot be provided in the event that a dedicated phone line or Ethernet connection is not available. In this case travel costs and travel time will be charged for site visits as required.

Safety issues

It is important to note that the rate of lumber stack advancement and the circulating air volume in the end chambers of a CDK system impacts directly on the exiting air temperature at the open ends of the CDK's:

- Over speeding the CDK will raise the exiting air temperature.
- Insufficient air flow in the end sections will not allow sufficient heat transfer between the hot dry lumber and the cold green lumber.

KDS Windsor has addressed these issues by:

- Accurately controlling the CDK advance rate using our DrySpec® CDK and DryTrack® CDK systems.
- Selecting a fan and motor configuration in the end sections which will ensure effective heat transfer.
- DrySpec® CDK will monitor the exiting temperature at the open doorways and activate alarm and safety procedure should a dangerous high temperature situation arise.

The KDS Windsor CDK system includes visual and audible alarms which will signal when a push is about to occur. These safety systems will be installed at both ends of the chamber as each track is controlled independently. Both these issues need ongoing monitoring with procedures put in place by your operators so as to ensure that you do not end up with an unsafe situation at the ends of the CDK.

Base Specifications:

Stack configuration:	
Nominal thickness	2"
Target thickness	1.71"
Package width	10'
Layers per package	31
# of packages high per stack	3
Sticker thickness	.75"
Bolster thickness	3.5"
Pack height	75.51"
Total stack height	233.53"
Cart height	15"
Top weight height	7"
Total load height above rail	21 – 3 1/2"
General design specifications:	
Number of CDK's proposed	1
CDK	CDK-351-PS-KDS
Total CDK length	Nominally 351' (may vary) + 8' for vapor extract modules= 359'
Infeed/outfeed track length	150' at each end of CDK
Total length with in/out track	659'
Guaranteed annual production	280MM bd/ft per CDK
Design operating hours/yr.	8,400
CDK structure:	
CDK internal structure	Aluminum structure with stainless steel column footings in the MD section, 316 stainless steel structure in the ER sections
Housing design	Walls and roof – 304 stainless steel inner tray system with corrugated aluminum exterior cladding, vented and self-draining in the MD and 316 stainless steel in the ER sections
Insulation type	Resin impregnated fiberglass
Fasteners	All stainless-steel bolts and screws
# of access doors and location	Total of 20 with 16 at ground level and 4 at fan deck level
Pusher system:	
Number of pushers	2 @ 5 HP each
Pusher design type	Hydraulic design (located under the load)
Pusher location	Just outside ER chambers under each green load track
Carts Linked together	Yes
Hydraulic tank capacity	Approximately 20 gallons each 2 total
Heat plant data:	
Heating method	Direct fired green sawdust gasifier
Fuel Type	Green sawdust
Size of heat plant in Btu/hr.	50MM btu/hr
Wood fuel MC wet basis	48% minimum, 56% maximum
Wood particle size required	9/16" screened material
Approx. max. fuel usage	8 tons/hr per burner
Incline screw motor	15 HP
Fuel hopper drag chain motor	2 @ 7.5 HP*
Combustion air blower motor	25 HP* (TBD)

Ignition air blower motor	20 HP* (TBD)
Bridgwall air blower motor	3 HP*
Ash screw motors	2 @ 3 HP* each
Ash Transfer screw motor	3 HP
Recirculation blower	400 HP* (TBD)

CDK fan system:

MD fan system	21 x fans @ 76" – 8 blade Smithco
MD fan motor	40 HP* Toshiba motors (TBD)
ER fan system	Each ER = 7 fans @ 76" – 4 blade Smithco x 2 ER's = 14 fans total
ER fan motor	25 HP* Toshiba motors (TBD)
Total # of fans per CDK	35
CDK fan motor controls	VFD
Internal/External drive	External 4-bearing shaft
Direct coupled or belt drive	Gates Polychain Drives
Fan bearing grease Lines	All SST lines w-SST flex tubes from exterior catwalk to bearings
MD fan shafts	2-7/16" T.G.P. steel
ER fan shafts	2-3/16" T.G.P. stainless steel
MD fan shaft support tubes	6" x 8" x 3/8" steel tube - Painted
ER fan shaft support tubes	6" x 8" x 3/8" stainless steel tube and bearing supports
Fan system belt guards	OSHA approved design with hinge style swing open

Air baffling system:

Overhead baffling	Kiln duty fiber brush baffles above each track
Vertical baffling	Aluminum spring return sidewall baffles on each side of load
Number of vertical baffles	<ul style="list-style-type: none"> • MD = 4 pair with 1 pair at each load door • ER = 6 pair in each ER = 12 pair total
Zones per ER	3

Wet bulb control system:

Control method	Fresh air inlet damper plus tubeaxial fan forced air
# of W.B. sensors	2
W.B. assembly access	Via sidewall access doors
Tim air blower motor option	15 HP*

Vapor extraction modules:

Vapor extraction motors	20 HP* each
-------------------------	-------------

DrySpec® CDK control system:

PLC	Allen-Bradley ControlLogix
HMI	Allen-Bradley FactoryTalk
DrySpec® CDK control PC	All solid state, fan-less NUC PC
# of D.B.'s in MD chamber	64 RTD's
# of D.B.'s in ER chambers	6 in each ER = 12 total in ER's

* Motor requires VFD by client

Scope of Supply:

Concrete foundations and site work:	By KDS Windsor	By client
• Site survey, soil testing, concrete testing and professionally engineered design of civil work		✓
• Profile layouts and point load information	✓	
• Required PE stamped foundation drawings for the CDK and burner	✓	
• Required PE stamped electrical drawings		✓
• Purchase of groundwork, site leveling and compaction to minimum 2500 PSF load bearing capacity per our design		✓
• Concrete supply and installation for CDK foundations		✓
• Rails, rail fixings, and pit covers		✓
• Electrical wiring, conduit, MCC equipment and field installation		✓
• Fire suppression system		✓
• Control and MCC room		✓
• On-site Coordinator		✓
• Obtain building permits		✓
• Provide 480 VAC @ required amps to MCC room		✓
• Provide condensate drain piping to CDK to accept 17,000 gallons daily per CDK		✓
• Provide dry compressed air @ 85 psi to sensor lift arm assemblies, including all required piping		✓
• Responsibility to receive, unload and inspect all items for shipping damage, note the bill of lading and notify KDS Windsor within 48 hours of receipt of shipment. KDS Windsor will not be responsible for any damages that have not been handled as described above. Individual boxes do not have to be opened for inspection.		✓
Installation:		
• CDK installation supervisor, crew and tools	✓	
• KDS Windsor site staff accommodation, meals and local travel costs	✓	
• Telehandler forklift for installation crew		✓
• Hydraulic fluid and welding gases as required		✓
• Crane hire	✓	
• Provide sufficient 120-volt power at the kiln(s) location, for use by KDS Windsor installation personnel, with a minimum of eight power receptacles fed by two minimum 30 amp breakers.		✓
• Provide clean water for wet bulb sensors and for burner water pit		✓
• Provide drinking water and sanitary facilities for installation crew		✓
• Receptacle for debris resulting from KDS Windsor installation work and removal from site		✓
Training and manuals:		
• Training of site operators on CDK operation, maintenance and safety	✓	
• Supply of operating and maintenance manuals - 2 sets	✓	
Fuel delivery:		
• Supply an adequate amount of fuel into burner so that the burner will never run out of fuel		✓

Fuel Silo Cyclone Specs

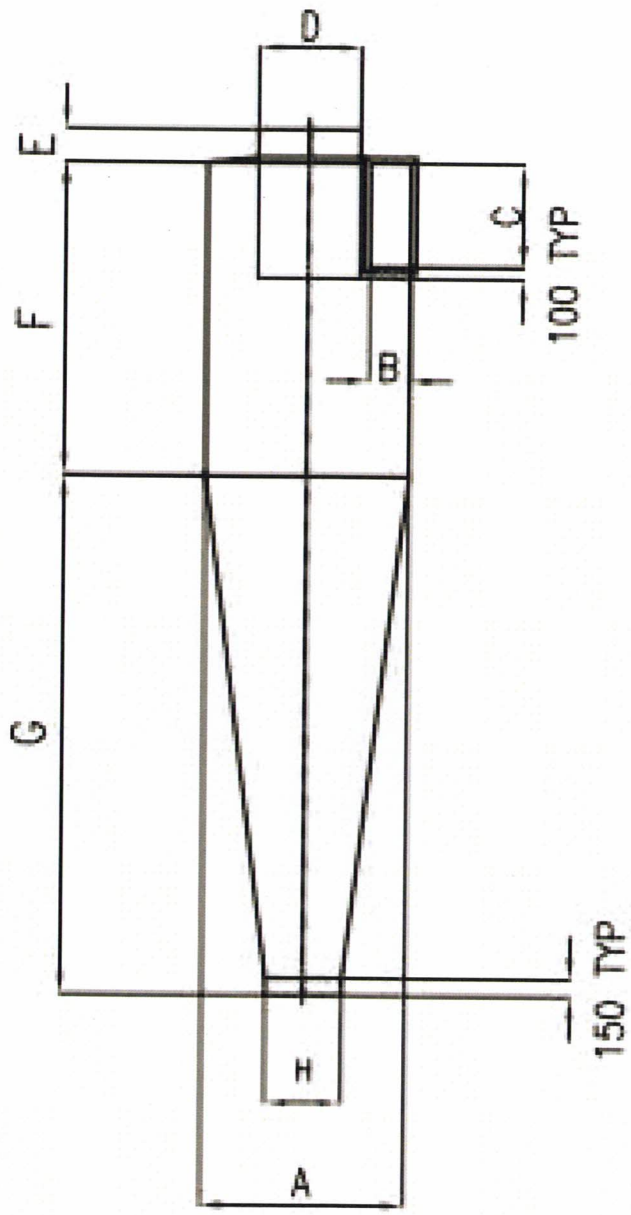

MODEL HE

A HIGH EFFICIENCY
MEDIUM PRESSURE
DROP CYCLONE. SUITABLE
FOR MOST APPLICATIONS. 

GENERAL NOTES:

- 1) "B", "C", "D" & "G" ARE INTERNAL DIMENSIONS.
- 2) PRESSURE DROP @ NOM. AIRFLOW IS 750 Pa (3" W.G.)

MODEL	AIR FLOW		A	B	C	D	E	F	G	H	MATERIAL.
	m ³ /s	CFM									
HE 1400	2.94	6227	1400	280	700	700	100	2100	3500	520	

Dry Chip Baghouse Specs

Company: Crow Engineering
Location: Weyerhaeuser Raymond, WA

Date: May 25, 2023

Specifications Sheet:

Superior Filter Model P12-338-12

1. 5,070 sq. ft. of cloth
2. 42' 0" overall height by 12' 3" Ø
3. 16 oz. polyester felt bags, snap-in style, no tools required
4. Galvanized bag cages
5. Walk-in clean air plenum (32" x 78" walk-in man door w/view window)
6. Explosion venting (65:1 vent ratio)
7. 3/16" mild steel plate welded construction
8. Adapter fitting on cone for level sensor, level indicator not included
9. 60° cone to 16" Ø outlet, flanged to match airlock
10. Hopper access door
11. Tangential inlet, flanged and punched
12. Clean-air outlet, flanged and punched
13. Support structure with 72" clearance under cone, seismic zone III design
14. Caged access ladder(s) with service platform(s)
15. Control box assembly, 120v, single phase
16. Weather-proof duplex outlet, 120v, single phase
17. Magnehelic pressure gauge kit
18. "Auto-clear" system for magnehelic gauge dirty-air side line
19. Purge-air pump package with 10 Hp TEFC motor and drives
20. Compressed air requirement for purge-arm activation (0.25 scfm @ 80 psi)
21. Purge arm compressed air/filter-regulator-lubricator set
22. One (1) coat red oxide primer, one (1) coat industrial enamel
23. One (1) year warranty on all parts and workmanship
24. Two (2) owner's manuals
25. Optional: Sprinkler heads, in top of clean air plenum

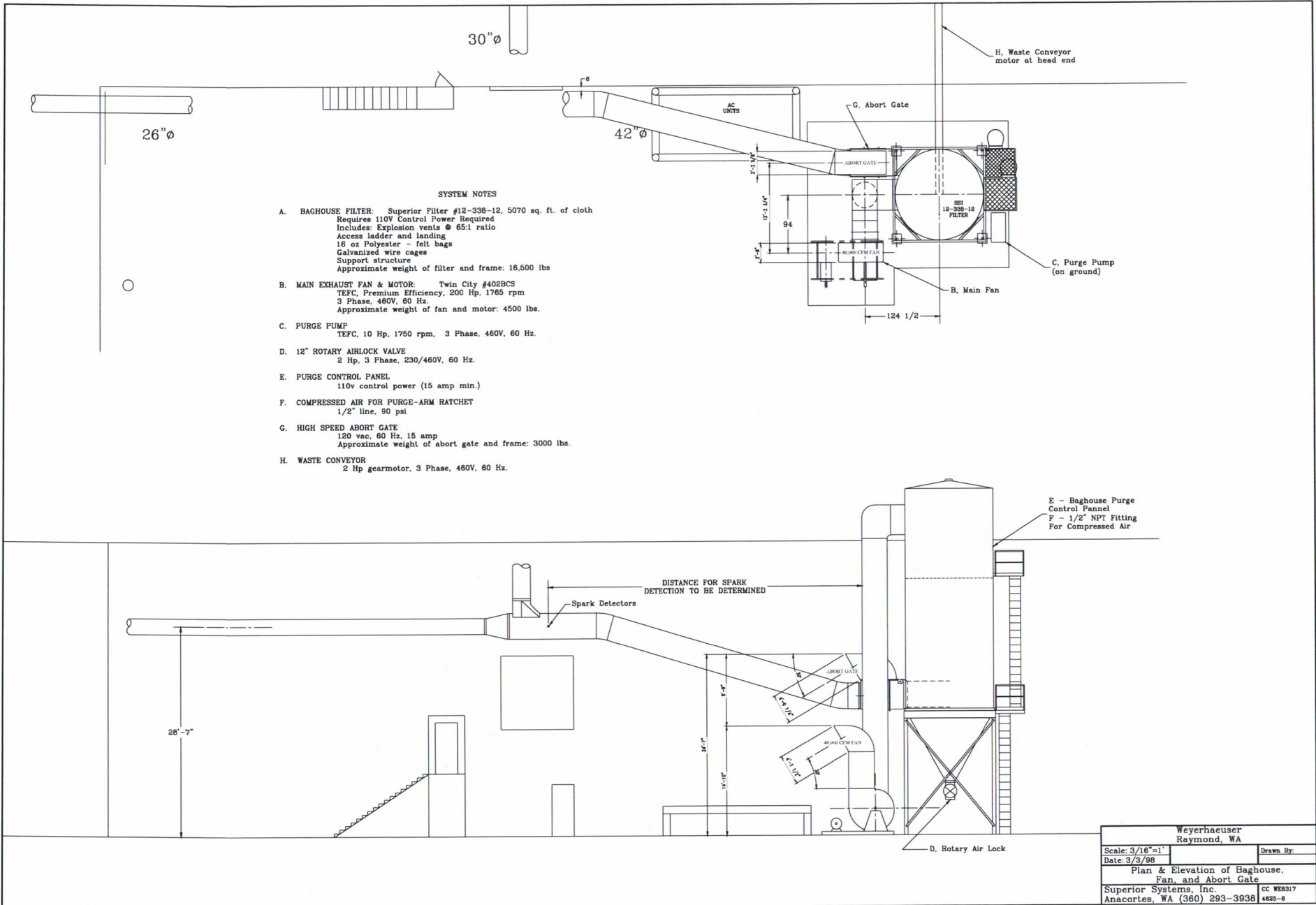

SYSTEM NOTES

- A. BAGHOUSE FILTER: Superior Filter #12-338-12, 5070 sq. ft. of cloth
 Requires 110V Control Power Required
 Includes: Explosion vents @ 65:1 ratio
 Access ladder and landing
 16 oz Polyester - felt bags
 Galvanized wire cages
 Support structure
 Approximate weight of filter and frame: 16,500 lbs
- B. MAIN EXHAUST FAN & MOTOR: Twin City #402BCS
 TEFC, Premium Efficiency, 200 Hp, 1765 rpm
 3 Phase, 460V, 60 Hz.
 Approximate weight of fan and motor: 4500 lbs.
- C. PURGE PUMP
 TEFC, 10 Hp, 1750 rpm, 3 Phase, 460V, 60 Hz.
- D. 12" ROTARY AIRLOCK VALVE
 2 Hp, 3 Phase, 230/460V, 60 Hz.
- E. PURGE CONTROL PANEL
 110v control power (15 amp min.)
- F. COMPRESSED AIR FOR PURGE-ARM RATCHET
 1/2" line, 80 psi
- G. HIGH SPEED ABORT GATE
 120 vac, 60 Hz, 15 amp
 Approximate weight of abort gate and frame: 3000 lbs.
- H. WASTE CONVEYOR
 2 Hp gearmotor, 3 Phase, 460V, 60 Hz.

Weyerhaeuser Raymond, WA	
Scale: 3/16"=1'	Drawn By:
Date: 3/3/98	
Plan & Elevation of Baghouse, Fan, and Abort Gate	
Superior Systems, Inc.	CC W65317
Anacortes, WA (360) 293-3938	4625-8

APPENDIX D. "EPD RECOMMENDED EMISSION FACTORS FOR LUMBER KILN PERMITTING IN GEORGIA"

EPD Recommended Emission factors for Lumber Kiln Permitting in Georgia

Below please see the emission factors we have been using lately for Lumber Mill Applications:

Steam Heated Kiln

VOC = 4.0 lbs/Mbf (pounds per thousand board feet)

Formaldehyde = 0.0149 lb/Mbf

Methanol = 0.236 lb/Mbf

Acetaldehyde = 0.0054 lb/Mbf

Acrolein = 0.006 lb/Mbf

Phenol = 0.0103 lb/Mbf

Combined HAP = 0.261 lb/Mbf

Direct-fired Kiln

VOC = 4.0 lbs/Mbf

Formaldehyde = 0.0386 lb/Mbf

Methanol = 0.161 lb/Mbf

Acetaldehyde = 0.045 lb/Mbf

Acrolein = 0.006 lb/Mbf

Phenol = 0.0103 lb/Mbf

Combined HAP = 0.261 lb/Mbf

The above emission factors are based on recent NCASI test results that are not published yet.

For PM/PM10/PM2.5, we have been using stack tested emission data that were used in Title V Application No. 21615 for West Fraser – Augusta Lumber Mill, which are:

PM = 0.14 lb/Mbf

PM10 = 0.104 lb/Mbf

PM2.5 = 0.099 lb/Mbf

NO_x = 0.28 lb/Mbf (for Wood fired)

CO = 0.73 lb/Mbf (for Wood Fired)

S_O2 = 0.025 lb/MM Btu (for Wood Fired)

Total GHG = 209.6 lb/MM Btu (for wood fired)

NOTES ON PM EMISSION FACTORS:

The NCASI emission factors that are used in the emission calculations were initially developed for batch lumber kilns. Since continuous kilns are a new technology, there is limited testing data. No NCASI reviewed testing data currently exists for continuous kilns. The emission factors for a continuous kiln are expected to be equal to or less than that of a batch kiln. **The exception** to this would be data reviewed regarding particulate matter emissions as part of the preliminary determination for Simpson Lumber Company, LLC (Application Number 20735). Based on a review of the preliminary determination document, the best available emission factors for particulate related emissions are based on tests conducted at **Bibler Brothers Lumber Company, Russellville, AR.** The Bibler Brothers data is for filterable PM only. The filterable PM emission factor is 0.068 lb/MBF. Condensable PM is based on unpublished data provided by NCASI. NCASI recommends a ratio of Condensable to Filterable PM of 1.016. The Condensable PM emission factor used is therefore 0.069 lb/MBF. Filterable PM10 is assumed to be 50% of filterable PM (based on Permit NO. 2421-107-0011-V-02-3 issued to Rayonier Wood Products LLC-Swainsboro Sawmill). Filterable PM2.5 is assumed to be 87% of PM10 based on AP-42 for wood combustion. All condensable PM is assumed to be PM10 and PM2.5. The resulting PM, PM10, and PM2.5 emission factors are 0.138 lb/MBF, 0.104 lb/MBF, and 0.099 lb/MBF, respectively.

**APPENDIX E. NCASI TECHNICAL BULLETIN NO. 1013: "A
COMPREHENSIVE COMPILATION AND REVIEW OF WOOD-FIRED
BOILER EMISSIONS"**



NATIONAL COUNCIL FOR AIR AND STREAM IMPROVEMENT

**A COMPREHENSIVE COMPILATION
AND REVIEW OF WOOD-FIRED
BOILER EMISSIONS**

**TECHNICAL BULLETIN NO. 1013
MARCH 2013**

**by
Arun V. Someshwar, Ph.D.
NCASI Southern Regional Center
Newberry, Florida**

4.1 Organic Air Toxic Emissions from Wood-Fired Boilers

Table 4.1 provides a summary of gaseous organic and inorganic air toxic emissions from wood-fired boilers. Information concerning the specifics of each boiler, such as the fuel description, boiler type, boiler heat input, and the PM control device, as well as average emissions for each air toxic corresponding to each boiler, is provided in electronic format (Excel) in Table AA-1 (downloadable from the NCASI members only website).

As mentioned in Technical Bulletin 973 (NCASI 2010), even in cases where the majority of data originated from the AP-42 background document for Section 1.6, the mean emission rates for wood-fired boilers as estimated by NCASI were not always in agreement with the means presented in AP-42. This is the result of rigorous statistical data treatment procedures applied by NCASI to these data sets that are often “censored” (comprising of non-detects). Two key procedures that were applied to these data even before the Kaplan-Meier subroutine to handle censored data sets was applied included (1) the rejection of all non-detect data where the detection limits exceeded the highest detected observation in a data set, and (2) the determination of statistical outliers that, once identified, were rejected only after graphical confirmation. Thus, the mean for some compounds including acetaldehyde, acrolein, benzene, hydrogen chloride, and phenol were different (mostly lower) than the averages presented in EPA’s AP-42 document. EPA’s procedures used in the AP-42 document called for assigning one-half the method detection limit to all non-detect values, and performing only a qualitative evaluation of potential outliers.

Relative to the new air toxic emission data obtained from recent Boiler MACT and related company test reports, these tests were conducted on two electrical generating units (EGUs), 28 pulp mill bark/wood residue boilers, and 38 wood products mill wood-fired units. Of the 68 wood-fired units, 44 were stokers, seven suspension burners, nine fuel cells, two Dutch ovens, five fluidized beds and one unspecified type.

Relative to the old AP-42 gaseous organic and inorganic air toxic emission test data retained in Table 4.1, those data corresponded to a total of 64 wood-fired boilers, all of which reported burning “inland” wood residues during the emission testing period. Fifty-seven of the 64 boilers in the AP-42 data set corresponded to wood-fired boilers burning “inland” wood residues for which data were summarized in electronic spreadsheet files supporting the background document to EPA’s AP-42 chapter on wood residue combustion (ERG 2001). The data for the remaining seven boilers were available in NCASI files (much of the data on pulp mill wood-fired boilers in EPA’s AP-42 background document were also available in NCASI files). Of the 57 boilers in the AP-42 data set, 12 were located at furniture plants, 11 were electric generating units (EGU), five were located at pulp mills, and 29 were located at wood products mills. The data for non-FPI mills were included in this summary since the wood fuels and operating practices for these boilers were thought to be similar to those of boilers burning wood residues at pulp and paper mills and wood products plants, with one exception. The boiler located at the American Ref-Fuel Company, Niagara Falls, New York (B08) was reportedly burning “wood wastes,” but further investigation indicated that treated wood was part of the wood fuel mix fired in this boiler during the tests. Thus, data for this boiler were excluded from the analysis.

Prominent VOCs emitted as a result of wood combustion include acetaldehyde, acrolein, benzene, formaldehyde, methanol and naphthalene.

Table 4.1 Summary of Air Toxic Emissions from Wood-Fired Boilers (lb/10⁶ Btu)

Compound	Sources*	Detects	Min	Max	Median	Mean	Std. Dev.	UPL**
Acetaldehyde ^a	28	23	1.56E-05	1.96E-03	1.57E-04	2.83E-04	4.11E-04	1.28E-03
Acetone	10	7	7.84E-05	7.14E-03	2.14E-04	1.19E-03	2.10E-03	6.43E-03
Acetophenone	4,2	2	3.23E-09	3.68E-06	1.84E-06	1.84E-06	--	--
Acrolein ^a	12,10	6	3.15E-05	1.10E-03	1.27E-04	2.60E-04	3.78E-04	8.84E-04
Benzaldehyde	7,5	2	<9.60E-07	4.22E-04	5.40E-05	1.89E-04	1.90E-04	6.84E-04
Benzene ^b	31,30	26	2.41E-07	1.02E-02	2.35E-04	9.80E-04	2.02E-03	5.87E-03
Bis(2-Chloroisopropyl) ether	1	1	--	--	6.15E-07	6.15E-07	--	--
Bis(2-ethylhexyl)phthalate	1	1	--	--	4.65E-08	4.65E-08	--	--
Bromobenzene	1	0	<7.67E-06	<7.67E-06	--	--	--	--
Bromodichloromethane	3	0	ND	<5.90E-03	--	--	--	--
Bromomethane	3	3	2.38E-06	2.80E-05	3.67E-06	1.14E-05	1.44E-05	3.52E-05
Butylbenzylphthalate	2	1	ND	2.70E-05	1.34E-05	1.34E-05	--	--
n-Butylaldehyde	2	2	6.05E-05	7.70E-05	6.88E-05	6.88E-05	--	--
Carbon Tetrachloride	7,5	3	<2.65E-06	4.70E-05	2.55E-06	2.01E-05	2.55E-05	6.22E-05
Carbon-Disulfide	1	1	--	--	1.25E-04	1.25E-04	--	--
3-Carene	2	0	<2.30E-03	<2.6E-03	--	--	--	--
Chlorobenzene	3,2	2	5.54E-10	3.30E-05	1.66E-05	1.66E-05	--	--
Chloroform	7,5	3	2.55E-06	4.70E-05	2.55E-06	2.01E-05	2.55E-05	6.22E-05
Chloromethane	4	3	<1.6E-08	9.80E-05	2.66E-05	3.78E-05	4.21E-05	1.07E-04
2-Chloronaphthalene	1	1	--	--	2.41E-09	2.41E-09	--	--
2-Chlorophenol	5,4	1	<2.09E-08	5.70E-08	1.85E-08	1.85E-08	--	5.70E-08
4-Chlorotoluene	1	0	<1.83E-06	<1.83E-06	--	--	--	--
cis-1,3-Dichloropropene	1	0	<5.48E-06	<5.48E-06	--	--	--	--
m,p-Cresol	1	0	<1.00E-05	<1.00E-05	--	--	--	--
o-Cresol	1	0	<1.00E-05	<1.00E-05	--	--	--	--
Crotonaldehyde	3,2	2	1.08E-05	7.89E-05	4.49E-05	4.49E-05	--	--
Cumene	2,1	1	--	--	1.77E-05	1.77E-05	--	--
p-Cymene	2,1	1	--	--	2.61E-06	2.61E-06	--	--
Decachlorobiphenyl	1	1	--	--	2.65E-10	2.65E-10	--	--
Dibromochloromethane	1	0	<7.48E-07	<7.48E-07	--	--	--	--
1,2-Dibromoethane	1	0	<1.83E-06	<1.83E-06	--	--	--	--
1,2-Dibromo-3-chloropropane	1	0	<1.10E-06	<1.10E-06	--	--	--	--
1,2-Dibromoethene	1	1	--	--	5.48E-05	5.48E-05	--	--
1,1-Dichlorobenzene	1	0	<1.79E-05	<1.79E-05	--	--	--	--

(Continued on next page. See note at end of table.)

Table 4.1 Continued

Compound	Sources*	Detects	Min	Max	Median	Mean	Std. Dev.	UPL**
1,3-Dichlorobenzene	1	0	<1.64E-05	<1.64E-05	--	--	--	--
1,4-Dichlorobenzene	1	1	2.79E-04	2.79E-04	--	--	--	--
Dichlorobiphenyl	3	3	3.79E-10	9.26E-10	9.00E-10	7.35E-10	5.91E-05	9.75E-05
1,1-Dichloroethane	1	0	<2.99E-05	<2.99E-05	--	--	--	--
1,2-Dichloroethane	1	1	--	--	2.92E-05	2.92E-05	--	--
1,2-Dichloroethene	1	1	1.37E-03	1.37E-03	--	--	--	--
1,2-Dichloropropane	2	1	<7.30E-07	3.33E-05	1.68E-05	1.68E-05	--	--
Diethylphthalate	2	1	ND	2.70E-05	2.18E-05	2.18E-05	--	--
2,5-Dimethyl benzaldehyde	2	2	4.45E-05	1.09E-04	7.68E-05	7.68E-05	--	--
Dimethyl Sulfide	1	1	--	--	0 ppb	0 ppb	--	--
Di-n-Butyl Phthalate	2	2	8.53E-06	5.81E-05	3.33E-05	3.33E-05	--	--
4,6-Dinitro-2-methylphenol	1	1	--	--	2.10E-06	2.10E-06	--	--
2,4-Dinitrophenol	5,4	1	<1.64E-07	4.03E-07	1.31E-07	1.31E-07	--	4.03E-07
2,4-Dinitrotoluene	1	1	--	--	9.42E-07	9.42E-07	--	--
Di-n-octyl phthalate	1	1	--	--	1.10E-07	1.10E-07	--	--
Ethanol	5	1	<7.40E-04	1.69E-03	4.77E-04	4.77E-04	--	1.69E-03
Ethyl Benzene	6,3	3	1.33E-06	3.13E-05	3.13E-05	3.95E-04	6.54E-04	1.47E-03
Formaldehyde	34,33	30	<6.04E-06	5.10E-03	3.77E-04	1.02E-03	1.50E-03	4.64E-03
Hexachlorobenzene	1	1	--	--	1.03E-06	1.03E-06	--	--
Hexachlorobiphenyl	2	2	2.89E-10	8.01E-10	5.45E-10	5.45E-10	--	--
Hexaldehyde	4	3	9.82E-06	2.82E-04	4.16E-05	9.37E-05	1.27E-04	3.03E-04
n-Hexane	2	1	<5.20E-05	5.50E-04	2.88E-04	2.88E-04	--	--
Hexachlorobutadiene	1	0	<3.65E-07	<3.65E-07	--	--	--	--
Hydrogen Chloride ^b	31	27	3.83E-06	3.91E-02	3.46E-04	4.36E-03	9.31E-03	2.69E-02
Hydrogen Chloride ^c	13	11	1.72E-05	1.39E-03	1.11E-04	2.66E-04	3.87E-04	1.22E-03
Hydrogen Fluoride ^b	17	11	<3.83E-06	2.54E-03	7.47E-05	2.35E-04	6.08E-04	1.72E-03
Hydrogen Fluoride ^c	5,3	2	ND	4.23E-05	8.50E-06	1.69E-05	2.24E-05	5.38E-05
Isobutanol	1	0	<3.00E-05	<3.00E-05	--	--	--	--
Isobutyraldehyde	1	1	--	--	1.47E-04	1.47E-04	--	--
Isopropanol	4	2	<1.00E-03	9.20E-03	1.10E-03	3.64E-03	5.48E-03	1.27E-02
Isovaleraldehyde	1	1	--	--	6.32E-05	6.32E-05	--	--
Methanol	10,9	5	<1.30E-04	1.48E-03	4.82E-04	7.32E-04	4.15E-04	1.42E-03

(Continued on next page. See note at end of table.)

Table 4.1 Continued

Compound	Sources*	Detects	Min	Max	Median	Mean	Std. Dev.	UPL**
Methyl Ethyl Ketone	10,7	6	4.85E-08	6.73E-05	5.39E-06	1.56E-05	2.43E-05	5.57E-05
Methyl Isobutyl Ketone	5,2	1	<6.10E-05	8.60E-04	4.45E-04	4.45E-04	--	--
2-Methylnaphthalene	2	2	4.05E-08	2.75E-07	1.58E-07	1.58E-07	--	--
Methylene Chloride	7	3	<1.00E-05	1.52E-03	2.82E-05	5.47E-04	4.93E-04	1.36E-03
Monochlorobiphenyl	1	1	--	--	2.18E-10	2.18E-10	--	--
Naphthalene	20,18	16	<1.13E-08	4.87E-04	8.13E-06	9.96E-05	1.38E-04	4.37E-04
2-Nitrophenol	5	1	<2.09E-08	9.71E-07	2.74E-07	2.74E-07	--	9.71E-07
4-Nitrophenol	5,4	1	<1.05E-07	2.90E-07	9.41E-08	9.41E-08	--	2.90E-07
Pentachlorobiphenyl	2	2	6.49E-10	1.76E-09	1.20E-09	1.20E-09	--	--
Pentachlorophenol	7	2	<4.19E-08	1.10E-06	4.48E-08	2.29E-07	3.43E-07	1.10E-06
Pentanal	1	1	--	--	1.53E-04	1.53E-04	--	--
2-Pentanone	1	0	<3.03E-05	<3.03E-05	--	--	--	--
Phenol	15,14	10	3.12E-09	1.51E-03	1.53E-05	1.60E-04	1.13E-04	4.38E-04
Propanol	1	0	<2.00E-05	<2.00E-05	--	--	--	--
Propionaldehyde	4	3	<7.7E-05	1.12E-03	2.14E-05	2.52E-04	5.32E-04	1.13E-03
Styrene ^a	4	2	<2.00E-06	1.86E-03	1.54E-05	4.77E-04	1.13E-03	2.34E-03
alpha-Pinene	4,1	1	--	--	8.36E-06	8.36E-06	--	--
beta-Pinene	4	2	1.67E-06	6.50E-03	1.10E-03	1.64E-03	4.01E-03	8.25E-03
alpha-Terpineol	3,1	1	--	--	4.73E-06	4.73E-06	--	--
Tetrachlorobiphenyl	2	2	1.60E-09	3.39E-09	2.50E-09	2.50E-09	--	--
Tetrachloroethene	2	1	<7.30E-07	4.89E-05	2.46E-05	2.46E-05	--	--
Tolualdehydes (m,p,o)	2	2	1.38E-04	1.82E-04	1.60E-04	1.60E-04	--	--
Toluene ^a	12,8	6	3.40E-08	9.00E-05	3.67E-06	2.11E-05	2.84E-05	9.29E-05
Tribromomethane	1	0	<3.65E-07	<3.65E-07	--	--	--	--
Trichlorobiphenyl	3	3	5.45E-10	5.51E-09	1.78E-09	2.61E-09	5.91E-05	9.75E-05
1,2,3-Trichlorobenzene	1	0	<2.19E-06	<2.19E-06	--	--	--	--
1,2,4-Trichlorobenzene	2	0	<3.65E-05	<1.10E-04	--	--	--	--
1,1,1-Trichloroethane	4	3	3.28E-06	1.70E-04	3.93E-05	5.78E-05	8.10E-05	1.91E-04
1,1,2-Trichloroethane	2	0	<1.02E-05	<2.4E-04	--	--	--	--
Trichloroethylene	4,2	1	<1.83E-06	3.88E-05	1.99E-05	1.99E-05	--	--
Trichlorofluoromethane	3	1	<3.65E-07	4.05E-05	1.59E-05	1.59E-05	--	4.05E-05
2,4,6-Trichlorophenol	6	1	<2.09E-08	1.09E-06	2.76E-07	2.76E-07	--	1.09E-06
1,2,3-Trichloropropane	1	0	<2.19E-06	<2.19E-06	--	--	--	--
Valeraldehyde	2	2	9.27E-05	1.53E-04	1.23E-04	1.23E-04	--	--
Vinyl Chloride	1	1	--	--	1.84E-05	1.84E-05	--	--

(Continued on next page. See note at end of table.)

Table 4.1 Continued

Compound	Sources*	Detects	Min	Max	Median	Mean	Std. Dev.	UPL**
m,p-Xylene	7,3	3	6.90E-10	7.82E-06	2.79E-06	3.54E-06	3.96E-06	1.01E-05
o-Xylene	5,3	3	2.83E-10	3.13E-05	2.61E-06	1.13E-05	1.74E-05	4.00E-05
Xylenes (mixed isomers)	5,2	2	9.73E-10	1.04E-05	5.22E-06	5.22E-06	--	--

NOTES: Shaded rows show statistics derived exclusively from new data obtained from recent Boiler MACT and related company test reports.

Averages are not estimated when data set has all non-detects (NDs); only min and max DLs are provided in those cases.

*"Sources" If two number entries are shown, the first number represents the total number of sources that were tested, and the second number represents the number of sources that were included in the analysis for estimating averages; the difference represents sources where data were rejected mainly because they yielded non-detects with detection limits exceeding the highest detected observation. Occasionally, an observation confirmed to be a statistical outlier was also rejected.

**UPL Upper prediction limit estimated using mean + 1.65 x std. dev. for normally distributed data and the Chebyshev Inequality with 85% confidence coefficient for non-normally distributed or skewed data.

^a See Section 4.5 for further discussion. ^b Boilers with dry PM controls. ^c Boilers with wet PM control (wet scrubbers or wet ESP).

ND = non-detect; detection limit unknown.

5.0 CRITERIA POLLUTANT AND GHG EMISSIONS FROM WOOD-FIRED BOILERS

The principal criteria pollutant emissions of concern from wood combustion are particulates, CO, and NO_x. The ash content of stem wood fuel (wood chips, sanderdust, sawdust, planer shavings, etc.) ranges from 0.3 to about 3.0% (dry basis), while the ash content of bark fuel ranges from 3 to 10% (dry basis, median 5.2%, mean 8.0%) (NCASI 1999). Thus, the ash content of bark and wood fuels is generally lower than the ash content of most coals. However, uncontrolled particulate emissions from bark and wood combustion result from both the inorganic content of the bark/wood fuel and from the unburned carbon in the fly ashes (from incomplete combustion). Also, like coal combustion, uncontrolled particulate emissions will be greater where fly ash reinjection is practiced.

NO_x emissions are mainly the result of fuel NO_x, with most inland bark nitrogen contents being in the 0.1 to 0.3% range (dry basis). Average NO_x emissions from wood combustion in typical pulp mill boilers are lower than those from coal or residual oil combustion, but slightly higher than average NO_x emissions from natural gas and distillate oil burning. However, combustion of wood fuels containing nitrogen from other sources (e.g., urea formaldehyde resin) will result in additional NO_x emissions (fuel NO_x).

SO₂ emissions from wood combustion are very low, since bark and other wood residues contain very little sulfur (NCASI 1978). CO emissions and other products of incomplete combustion are highly variable and are a function of boiler design, operating conditions, combustion efficiency, and fuel quality.

A significant amount of criteria pollutant emissions data were also generated during the recent Boiler MACT-related testing effort on wood-, combination wood- and fossil fuel-fired industrial boilers. Just as for the data on air toxics, NCASI conducted a detailed review of test reports from the Boiler MACT and related testing programs for the data on criteria pollutants. For the criteria pollutants, more emphasis was placed on checking PM, PM_{2.5}, CPM, and THC results. Since CO, SO₂, and NO_x measurements were obtained via continuous analyzers, which were found to be generally reliable, less detailed examination of these pollutants was carried out.

Table 5.1 shows the minimum, maximum, median, mean, standard deviation and upper prediction limit derived from the test results in these reports for THCs (total hydrocarbons) as C, TNMHCs (total non-methane hydrocarbons, also called VOCs) as C, SO₂, CO, NO_x¹ and condensable particulate matter (CPM). Note THC values were obtained from EPA Method 25A measurements. Where methane (using EPA M18) was also measured, it was subtracted from the Method 25A THC value to obtain the TNMHC value. Table AA-5, downloadable from the NCASI members only website, provides details of fuel description, boiler type, boiler heat input, and the PM control device, as well as average emissions of various criteria pollutants, for all the wood-fired boilers where data are summarized in Table 5.1. The factors in Table 5.1 apply to the burning of predominantly bark and/or wood residues in industrial boilers. Considering the vast majority of these tests were conducted after 2008, these emission factors are considered to be more representative of current boiler operations compared with those in Section 1.6 of EPA's AP-42 document, the latter being based mainly on stack tests conducted 10 to 30 years ago.

¹As indicated in footnote f of Table 5.1, NO, NO₂, and NO_x were measured simultaneously during 6 runs in one 100% wood-fired stoker unit, yielding an average NO₂/NO_x ratio of 6.9%.

Table 5.1 Uncontrolled VOC, CO, SO₂, NO_x and CPM Emissions from Wood Combustion Units^a

	Sources	Min	Max	Median	Mean	StdDev	UPL ^j
Volatile Organic Compounds - all sizes & types							
THCs as C ^b	19 ^d	5.69E-04	3.26E-02	4.40E-03	7.62E-03	8.40E-03	2.81E-02
TNMHCs as C ^c	11 ^c	3.32E-04	1.90E-02	2.57E-03	4.44E-03	4.90E-03	1.64E-02
Carbon Monoxide							
<i>Stokers</i>	26	1.82E-02	2.23E+00	5.02E-01	7.24E-01	6.69E-01	1.95E+00
<i>Fuel Cells/Dutch Ovens</i>	8	1.16E-01	9.04E-01	3.60E-01	4.44E-01	3.02E-01	9.97E-01
<i>Suspension Burners</i>	5	5.42E-02	2.28E+00	2.26E-01	5.98E-01	9.48E-01	2.34E+00
<i>Fluid Bed Combustors</i>	2	6.51E-02	8.05E-02	7.28E-02	7.28E-02	--	--
Sulfur Dioxide – all sizes & types							
	30	ND	6.62E-02	3.18E-03	1.06E-02	1.77E-02	4.31E-02
Oxides of Nitrogen ^{e,f} – all sizes & types							
<i>Wood w/o Significant UF Resin Content^g</i>	27	1.19E-01	4.21E-01	2.03E-01	2.12E-01	6.74E-02	3.27E-01
<i>Wood w/ Significant UF Resin Content^h</i>	8	3.90E-01	1.26E+00	7.82E-01	7.91E-01	3.18E-01	1.39E+00
Condensable Particulate Matter (CPM)							
<i>Boilers with ESPs/FFs</i>	13	1.91E-03	3.57E-02	5.86E-03	8.90E-03	9.19E-03	2.58E-02
<i>Boilers with Multiclones</i>	4	4.83E-03	1.94E-02	6.62E-03	9.37E-03	6.78E-03	2.18E-02
<i>Boilers with Wet Scrubbersⁱ</i>	3	3.03E-03	3.65E-02	3.93E-03	1.45E-02	1.90E-02	4.94E-02

^a Source – Boiler MACT testing in boilers firing essentially 100% wood residues and/or bark. ^b Total hydrocarbons expressed as C, using EPA Method 25A. ^c Total non-methane hydrocarbons (VOCs) obtained by applying the mean non-methane hydrocarbon to THC fraction of 58.3% estimated from simultaneous or near simultaneous measurements for methane and THCs on 11 wood-fired boilers (3 stokers, 5 fuel cells, 1 Dutch oven, 2 FBCs) to the average statistics on THCs for the 19 boilers. ^d Although THCs were measured on 19 boilers, only 11 of these were also measured for methane. ^e Value is for both wet and dry wood-fired boilers. ^f NO, NO₂ and NO_x were measured simultaneously during 6 runs in one 100% wood-fired stoker unit yielding an average NO₂/NO_x ratio of 6.9%. ^g For firing of wood without significant resin content (< 20% UF resin wood content) and all moisture contents. ^h Wood residues with >20% UF resin wood content. ⁱ Note that CPM emissions for wood-fired boilers with wet scrubbers could be influenced by the wet scrubber itself. ^j Upper Prediction Limit with 95% confidence interval; all data sets assumed to be normally distributed. ND = non-detect; detection limit unknown.

THCs were measured on 19 wood-fired boilers (two Dutch ovens, five fuel cells, nine stokers, two FBCs, and one suspension burner). However, methane was simultaneously measured only in 11 of these 19 boilers. A mean fraction of CH₄ (EPA M18) to THC as C (M25A) of 41.7% was computed for these 11 wood-fired boilers (three stokers, five fuel cells, one Dutch oven, and two FBCs). A mean fraction of 58.3% (100 – 41.7) was then applied to the estimates of THC for all 19 wood-fired boilers to yield corresponding estimates for TNMHCs (or VOCs) from wood combustion. Emission factors for THCs and TNMHCs are presented collectively for the entire group of wood combustion boiler types since insufficient data exist to warrant separating them into separate boiler type categories.

Emission factors for carbon monoxide, on the other hand, are separated by boiler type (stokers, fuel cells/Dutch ovens, suspension burners, fluid bed combustors) since sufficient data were available and the differing combustion dynamics in these boiler types would merit such categorization.

Emission factors for sulfur dioxide are lumped in one group, since the minimal amount of sulfur in the wood fuel, and subsequent capture of over 95% of this sulfur in the wood ashes (NCASI 1978), are the prime factors for these emissions.

Emission factors for the oxides of nitrogen or NO_x are categorized by boilers that burn wood without significant resin content (<20% UF resinated wood) and all levels of moisture content, and wood mixtures that have significant fractions of UF resinated wood (>20% resinated wood). Urea-formaldehyde-based resins contain significant amounts of nitrogen which result in elevated fuel NO_x contributions.

Relative to condensable particulate matter or CPM, only tests where the latest version of EPA Method 202 (promulgated in December 2010) was utilized were considered. For Boiler MACT-related testing, this corresponded to any testing carried out after July of 2009, since the facilities that conducted these tests were instructed by EPA to use OTM 28, which became the December 2010 version of EPA Method 202. It should be noted that the CPM emission factor in Section 1.6 of AP-42 is based on measurements made with the earlier version of Method 202 and could thus be considered invalid since they were not generated using the latest version of M202. In general, CPM emissions using the older M202 versions could be biased high for sources with SO₂ emissions or biased low for sources with ammonia emissions. However, boilers burning predominantly wood or wood-bark are expected to emit minimal amounts of SO₂ and NH₃.

Table 5.2 reproduces the estimates for filterable PM_{2.5} emissions from Section 1.6 of AP-42 (USEPA 2003), where PM_{2.5} is given as a fraction of total filterable PM (FPM). The fraction is provided for wood-fired boilers with several types of PM control devices. The 2009 and later stack test reports related to Boiler MACT data collection had FPM emissions data and corresponding filterable PM_{2.5} emissions data for 13 wood-fired boilers equipped with ESPs, two boilers equipped with mechanical collectors, and one with no PM control device. The ratio of filterable PM_{2.5} to total FPM was calculated for each of these PM control types and these data are summarized in Table 5.3.

One boiler equipped with an ESP and one with a fabric filter had questionable FPM_{2.5}/FPM ratios; both of these were discarded. For the remaining 11 wood-fired boilers equipped with ESPs, the average fraction of FPM that was filterable PM_{2.5} is estimated at ~41%, lower than the 65% in AP-42. The average fraction of FPM_{2.5}/FPM for the two boilers equipped with multiclones is estimated at 54%, identical to the fraction presented in AP-42 for units with multiclones and fly ash reinjection. Finally, the FPM_{2.5}/FPM fraction for a single boiler with no control is estimated at ~28% in Table 5.3 as opposed to 76% in AP-42.

APPENDIX F. EMISSION CALCULATIONS

Table F-1. Project-Wide Potential Emissions — Criteria Pollutant Summary

Emission Unit	Fugitive?	Potential Annual Emissions (tpy)							
		Total PM	Total PM ₁₀	Total PM _{2.5}	SO ₂	NO _x	VOC	CO	CO _{2e}
CDK	N	21.70	16.12	15.35	5.25	43.40	179.35	113.15	44,007
Chip and Bark Truck Bins	Y	9.45	4.47	0.68	--	--	--	--	--
Fugitive Emissions - Green Sawdust	Y	0.23	0.11	0.02	--	--	--	--	--
Haul Roads	Y	0.90	0.18	0.04	--	--	--	--	--
Cyclones	N	9.92	3.97	3.97	--	--	--	--	--
Total:		42.20	24.84	20.05	5.25	43.40	179.35	113.15	44,007

Table F-2. Facility-Wide Potential Emissions — Criteria Pollutant Summary

Emission Unit	Fugitive?	Potential Annual Emissions (tpy)							
		Total PM	Total PM ₁₀	Total PM _{2.5}	SO ₂	NO _x	VOC	CO	CO _{2e}
Wood Waste Collection - Cyclones ²	N	11.57	4.65	4.65	--	--	--	--	--
Fugitive Emissions - Roads ³	Y	0.90	0.18	0.04	--	--	--	--	--
Log Debarking ⁴	Y	6.5	3.6	0.5	--	--	--	--	--
CDK	N	21.70	16.12	15.35	5.25	43.40	179.35	113.15	44,007
Chip and Bark Truck Bins	Y	9.45	4.47	0.68	--	--	--	--	--
Fugitive Emissions - Green Sawdust	Y	0.23	0.11	0.02	--	--	--	--	--
Total Emissions (with fugitives):		50.34	29.12	21.23	5.25	43.40	179.35	113.15	44,007
Total Emissions (without fugitives):		33.27	20.77	19.99	5.25	43.40	179.35	113.15	44,007
PSD Major Source Thresholds:		250	250	250	250	250	250	250	100,000
PSD Threshold Exceeded¹ (Yes/No):		No	No	No	No	No	No	No	No

¹ PSD is only applicable for GHG if the PSD threshold is exceeded for it and another pollutant.

² "Wood Waste Collection - Cyclones" includes new cyclones added as part of the project and existing cyclones that remain unchanged.

³ Vehicle usage has been updated as part of the project, so fugitive road emissions have been recalculated.

⁴ "Log Debarking" emissions remain unchanged from the value included in Table 4.2 of the TSD to the current AOP (12AOP915). The PM value was estimated based on the PM/PM10 relationship displayed in ORCAA's 2021 AEI - Debarking tab.

Table F-3. Project-Wide and Facility-Wide Potential Emissions — HAP Summary

Total HAP ¹ (tpy):	16.45	
Maximum HAP (tpy):	10.55	Methanol

¹ After completion of the CDK Project, HAP emissions at the Facility will only be emitted from the CDK.

Table F-4. Project-Wide Potential Emissions — HAP/TAP Summary

Pollutant	CAS #	HAP?	TAP?	CDK Emissions		Averaging Period	Project Emissions		Modeling Required?
				(lb/hr)	(tpy)		SQER ¹	(lb/avg. period)	
Acetaldehyde	75-07-0	Yes	Yes	1.03	4.32	year	60	8,644	Yes
Acrolein	107-02-8	Yes	Yes	0.03	0.13	24-hr	0.026	0.75	Yes
Formaldehyde	50-00-0	Yes	Yes	0.32	1.34	year	27	2,678	Yes
Methanol	67-56-1	Yes	Yes	2.51	10.55	24-hr	1500	60.31	No
Propionaldehyde	123-38-6	Yes	Yes	0.02	0.10	24-hr	0.59	0.57	No
Carbon monoxide	630-08-0	No	Yes	26.94	113.15	1-hr	43	26.94	No
Nitrogen dioxide	10102-44-0	No	Yes	10.33	43.40	1-hr	0.87	10.33	Yes
Sulfur dioxide	7446-09-5	No	Yes	1.25	5.25	1-hr	1.2	1.25	Yes
Total HAP (tpy):					16.45				
Max Individual HAP (tpy):					10.55	Methanol			

¹ The SQER for each TAP is obtained from the 2019 WAC 173-460 TAP list.

Table F-5. CDK Parameter Inputs

Parameter	Value	Units	Source Notes
Total Kiln Heat Input	50	MMBtu/hr	Per vendor specification sheet received on May 16, 2023.
CDK Annual Operating Hours	8,400	hr/yr	Per vendor specification sheet received on May 16, 2023.
Annual Production	310	MMBF/yr	Per vendor specification sheet received on May 16, 2023.
Maximum Hourly Production	3.69E-02	MMBF/hr	Calculated by the following: Hourly Production (MMBF/hr) = Annual Production (MMBF/yr) / CDK Annual Operating Hours

Table F-6. CDK Criteria Pollutant and GHG Emissions

Pollutant	Emission Factor	Unit	Reference	Emissions (lb/hr)	Emissions (tpy)
PM	140	lb/MMBF	1	5.17	21.70
PM ₁₀	104	lb/MMBF	1	3.84	16.12
PM _{2.5}	99	lb/MMBF	1	3.65	15.35
CO	730	lb/MMBF	1	26.94	113.15
NO _x	280	lb/MMBF	1	10.33	43.40
Total VOC	--	--	2	42.70	179.35
VOC (Combustion)	6.19E-03	lb/MMBtu	3	0.31	1.30
VOC (Drying)	1,148.7	lb/MMBF	4	42.39	178.05
SO ₂	0.025	lb/MMBtu	1	1.25	5.25
CO ₂ e	--	lb/MMBtu	5	10,478	44,007
CO ₂	207	lb/MMBtu	5	10,340	43,427
N ₂ O	7.94E-03	lb/MMBtu	5	0.40	1.67
CH ₄	1.59E-02	lb/MMBtu	5	0.79	3.33

¹ Emissions for PM, CO, NO_x, and SO_x estimated using direct-fired continuous dry kiln emission factors from Georgia EPD's document entitled "EPD Recommended Emission Factors for Lumber Kiln Permitting in Georgia".

² Emissions for VOC determined by adding together indirect-heated batch dry kiln emission factors for douglas fir and wood-fired combustion emission factors.

³ VOC combustion emission factor based on NCASI Technical Bulletin No. 1013: A Comprehensive Compilation and Review of Wood-Fired Boiler Emissions, Table 5.1. Mean values used. VOC reported as total non-methane hydrocarbons (TNMHC) "as-C", determined using EPA Method 25A, and converted to WPP1¹ per WPP1 Section 8.0 Equation 1: VOC (WPP1) = VOC (as-C) + Methanol + Formaldehyde.

⁴ VOC drying emission factor based on the "EPA Region 10 HAP and VOC Emission Factors for Lumber Drying, January 2021". Emission Factor (lb/MBF) = 0.01460x - 1.77130, where x = max drying temp of heated air entering the lumber (200 °F).

⁵ GHG emissions are calculated based on the Global Warming Potentials (GWP) provided in Table A-1 of 40 CFR 98 and emission factors provided in Tables C-1 and C-2 for combustion of wood and wood residuals.

CO ₂	1
N ₂ O	298
CH ₄	25

Table F-7. CDK HAP/TAP Emissions

Pollutant	CAS #	HAP?	TAP?	Emission Factors ¹		Emissions	
				Combustion ² (lb/MMBtu)	Drying ^{3, 4} (lb/MMBF)	(lb/hr)	(tpy)
Acetaldehyde	75-07-0	Yes	Yes	2.83E-04	27.5	1.03	4.32
Acrolein	107-02-8	Yes	Yes	2.60E-04	0.5	0.03	0.13
Formaldehyde	50-00-0	Yes	Yes	--	8.6	0.32	1.34
Methanol	67-56-1	Yes	Yes	7.32E-04	67.1	2.51	10.55
Propionaldehyde	123-38-6	Yes	Yes	2.52E-04	0.3	0.02	0.10
Carbon monoxide	630-08-0	No	Yes	--	--	26.94	113.15
Nitrogen dioxide ⁵	10102-44-0	No	Yes	--	--	10.33	43.40
Sulfur dioxide	7446-09-5	No	Yes	--	--	1.25	5.25

¹ Emissions for HAP determined by adding together indirect-heated batch dry kiln emission factors for douglas fir and wood-fired combustion emission factors, except for formaldehyde, which uses a direct-fired emission factor.

² HAP combustion emission factors based on NCASI Technical Bulletin No. 1013: A Comprehensive Compilation and Review of Wood-Fired Boiler Emissions, Table 4.1. Mean values used.

³ HAP drying emission factors for acetaldehyde, acrolein, methanol, and propionaldehyde based on the emission factor summary table in "EPA Region 10 HAP and VOC Emission Factors for Lumber Drying, January 2021," where x = max drying temp of heated air entering the lumber (200 °F).

⁴ Due to formaldehyde's dependence on direct or indirect heating, the emission factor was scaled up from the value listed in the "EPA Region 10 HAP and VOC Emission Factors for Lumber Drying, January 2021," where x = max drying temp of heated air entering the lumber (200 °F). The value was scaled by the proportion of direct to indirect mean batch kiln emission factors for formaldehyde in the NCASI Wood Products Air Emission Factor Database – 2013 Update, which is shown below:

NCASI Direct-Fired Batch Kiln EF:	7.35E-02	lb/MBF	EPA Region 10 Indirect-Heated Batch Kiln EF:	1.80	lb/MMBF
NCASI Indirect-Heated Batch Kiln EF:	1.53E-02	lb/MBF			
Ratio of Direct-to-Indirect:	4.80E+00				

⁵ It is conservatively assumed that all NO_x is converted to NO₂.

Table F-8. Fugitive PM Input Parameters

Parameter	Value	Units	Source Notes
Truck Bins			
Bark Annual Throughput	121,186	tpy	See Fugitive PM tab.
Green Chips Annual Throughput	414,070	tpy	See Fugitive PM tab.
Planer Shavings Annual Throughput	58,212	tpy	See Fugitive PM tab.
Sawmill Operation - Hours per Day	20	hours/day	Per conversation with client, the sawmill operates in two 10-hour shifts.
Sawmill Operation - Days per Week	5	days/week	Per conversation with client, the sawmill operates Monday - Friday
Sawmill Operation - Weeks per Year	52	weeks/year	Per conversation with client, the sawmill operates 52 weeks per year.
Sawmill Operation - Annual Operating Hours	5,200	hours/year	Calculated by the following: Annual Operating Hours = (Hours/Day) * (Days/Week) * (Weeks/Year).
Fugitive Emissions - Green Sawdust			
Total Kiln Heat Input	50	MMBtu/hr	Per vendor specification sheet received on May 16, 2023.
CDK Annual Operating Hours	8,400	hr/yr	Per vendor specification sheet received on May 16, 2023.
Wet Green Sawdust Higher Heating Value	3,500	Btu/lb	Per the HHV of wet fuel in Weyerhaeuser's Greenville facility's CDK PTE calculations.
Green Sawdust Fuel Annual Throughput	60,000	tpy	Calculated by the following: Annual Green Sawdust Fuel (tpy) = Total Kiln Heat Input (MMBtu/hr) * CDK Annual Operating Hours (hrs/yr) * 106 (Btu/MMBtu) / HHV (Btu/lb) / 2000 (lb/ton).
Sawdust Surge - Hours per Week	100	hours/week	Per conversation with client, the operational surge is 100 hrs/wk (Monday - Friday).
Sawdust Surge - Days per Week	5	days/week	Assumed value, since the sawmill operates Monday - Friday.
Sawdust Surge - Hours per Day	20	hours/day	Calculated by the following: Hours per Day = (Hours/Week) / (Days/Week).
Sawdust Surge - Annual Operating Hours	5,200	hours/year	Calculated by the following: Annual Operating Hours = (Hours/Week) * (Weeks/Year).

Table F-9. Fugitive PM Throughput Data

Material	Annual Throughput ¹				Throughput Unit	Section
	2019	2020	2021	2022		
Wood Product (Douglas Fir)	99,914.33	125,245.32	143,303.83	166,910.44	MBF	Production
Wood Product (Hemlock)	67,220.85	70,590.17	61,250.57	0	MBF	Production
Bark, Burned for Energy Recovery On-Site	22,230	25,452.75	25,677.39	19,970.65	bdtons	Energy Fuel Sources
Shavings, Burned for Energy Recovery On-Site	12,554	8,484.25	8,558.13	6,656.88	bdtons	Energy Fuel Sources
Chips	93,387	129,120	134,236.57	111,472	bdtons	Production
Hog Fuel Mfg. Res., Otherwise Beneficially Reused	2,751	6,514	33,599.78	12,654	bdtons	Residuals and Waste
Sawdust By-Product sold	19,550	22,651	15,516.09	17,057	bdtons	Residuals and Waste
Shavings By-Product sold	12,554	13,244	9,842.07	6,193	bdtons	Residuals and Waste
Categorized Material	Annual Throughput ¹ (bdton)				Components	
	2019	2020	2021	2022		
Bark ²	24,981	31,966.75	0	32,624.65	Bark, Burned for Energy Recovery On-Site; Hog Fuel Mfg. Res., Otherwise Beneficially Reused	
Green Sawdust	19,550	22,651	15,516.09	17,057	Sawdust By-Product Sold	
Planer Shavings	25,108	21,728.25	18,400.2	12,849.88	Shavings, Burned for Energy Recovery On-Site; Shavings By-Product sold	
Chips	93,387	129,120	134,236.57	111,472	Chips	
Categorized Material	Ratio ¹ (bdton/MBF produced)				Max Ratio (bdton/MBF)	CDK Project Scaled
	2019	2020	2021	2022		
Bark	0.15	0.16	0.00	0.20	0.20	121,186
Green Sawdust	0.12	0.12	0.08	0.10	0.12	72,522
Planer Shavings	0.15	0.11	0.09	0.08	0.15	58,212
Green Chips	0.56	0.66	0.66	0.67	0.67	414,070

¹ Since fugitive emissions relate to the handling of byproduct and residual materials, exact throughputs have not yet been determined, so the projected post-project throughputs were estimated using annual production values from 2019 through 2022. Materials from Weyerhaeuser's production data were then grouped into the relevant categories for this project: bark, green sawdust, planer shavings, and green chips. Ratios were then calculated to relate annual material throughput to annual wood product production. Of these ratios, the maximum ratio was multiplied by the annual production rate for the CDK project and converted to a wet basis, assuming a moisture content of 50% for bark, green sawdust, and green chips and 20% for planer shaving. Since a green sawdust throughput is already specified for the green sawdust CDK burner (via burner capacity), the value in this table was not used in the PTE calculations.

² Due to log yard clean up activities in 2021, the "hog fuel beneficially applied" value does not accurately represent expected annual production rates of bark, so the scaled annual throughput of bark for the CDK project is based on 2019, 2020, and 2022 production rates.

Table F-10. Fugitive PM Emissions

Emission Unit	Material	Origin	Destination	Emission Factors (lb/ton) ¹			Capture Type	Capture Efficiency (%)	Annual Emissions (tpy) ³			Daily Emissions (lb/day) ⁴			Hourly Emissions (lb/hr) ⁵		
				PM	PM ₁₀	PM _{2.5}			PM	PM ₁₀	PM _{2.5}	PM	PM ₁₀	PM _{2.5}	PM	PM ₁₀	PM _{2.5}
Fugitive Emissions - Green Sawdust																	
Green Sawdust Sawmill Drop	Green Sawdust	Sawmill	Green Sawdust Conveyor	7.55E-03	3.57E-03	5.41E-04	Building Enclosure	See Footnote 1 (Min Wind Speed)	0.23	0.11	0.02	1.74	0.82	0.12	0.09	0.04	6.24E-03
<i>Fugitive Emissions - Green Sawdust Sub-Total:</i>									<i>0.23</i>	<i>0.11</i>	<i>0.02</i>	<i>1.74</i>	<i>0.82</i>	<i>0.12</i>	<i>0.09</i>	<i>0.04</i>	<i>6.24E-03</i>
Truck Bins																	
Bark Bins Truck Loadout	Bark	Bark Bins	Truck	0.064	0.030	4.56E-03	Steel Sidings	50%	1.93	0.91	0.14	14.84	7.02	1.06	0.74	0.35	0.05
Chips Bins Truck Loadout ⁶	Chips, Planer Shavings	Chip Bins	Truck	0.064	0.030	4.56E-03	Steel Sidings	50%	7.52	3.56	0.54	57.83	27.35	4.14	2.89	1.37	0.21
<i>Truck Bins Sub-Total:</i>									<i>9.45</i>	<i>4.47</i>	<i>0.68</i>	<i>72.67</i>	<i>34.37</i>	<i>5.20</i>	<i>3.63</i>	<i>1.72</i>	<i>0.26</i>
Total:									9.67	4.58	0.69	74.41	35.19	5.33	3.72	1.76	0.27

¹ Methods from AP-42 Section 13.2.4, Aggregate Handling and Storage Piles, are used to determine the emission factors and total emissions from raw material handling.

Uncontrolled Emission Factor (lb/ton) = 0.0032 x (k) x (U / 5)^{1.3} / (M / 2)^{1.4}, where:

Particle Size Multiplier (k) = 0.74 for PM
 0.35 for PM₁₀
 0.053 for PM_{2.5}

Mean Wind Speed (U) = 6.7 mph
 Minimum Wind Speed (U) = 1.3 mph

Material Moisture Content (M) = 25%

This wind speed is used for outdoor emission calculations from truck bin loadout. Source: Western Regional Climatological Center, Olympia, WA station
 This wind speed is used for the indoor emission calculations from the green sawdust drop. Source: AP-42 Section 13.2.4.

While the internal moisture of the wood particles may be around 50%, this variable (M) accounts for surface moisture. The lower end moisture content was chosen as a conservative estimate of annual surface moisture.

² The truck bins will be fitted with steel sidings, which prevent approximately 50% of fugitive emissions.

³ Annual Emissions = Emission Factor (lb/ton) x Qty Unloaded (ton/yr) / 2000 (lb/ton) * (100% - Capture Efficiency (%))

⁴ Daily Emissions = Hourly Emissions (lb/hr) * Hours per Day

⁵ Hourly Emissions = Emission Factor (lb/ton) x Qty Unloaded (ton/yr) / Annual Operating Hours (hours/yr) * (100% - Capture Efficiency (%)). For the purpose of these calculations, it is assumed that the hourly truck loadout rate is equivalent to the hourly rate of material sent to the truck bin.

⁶ While the planer shavings are blown to a cyclone on top of the chips bins that exausts to a baghouse, all planer shavings are assumed to be sent down into the truck bins in order to have a conservative estimate of the material transfer PM emissions from truck loadout.

Table F-11. Cyclones Input Parameters

Parameter	Value	Units	Source Notes
Sawmill Operation - Hours per Day	20	hours/day	Per conversation with client, the sawmill operates in two 10-hour shifts.
Sawmill Operation - Days per Week	5	days/week	Per conversation with client, the sawmill operates Monday - Friday
Sawmill Operation - Weeks per Year	52	weeks/year	Per conversation with client, the sawmill operates 52 weeks per year.
Sawmill Operation - Annual Operating Hours	5,200	hours/year	Calculated by the following: Annual Operating Hours = (Hours/Day) * (Days/Week) * (Weeks/Year).
Sawdust Surge - Hours per Week	100	hours/week	Per conversation with client, the operational surge is 100 hrs/wk (Monday - Friday).
Sawdust Surge - Annual Operating Hours	5,200	hours/year	Calculated by the following: Annual Operating Hours = (Hours/Week) * (Weeks/Year).
Fuel Silo Cyclone Exhaust Flow Rate	6,227	scfm	Per vendor specs, received June 29, 2023. Per email with Angela Cameron on July 11, 2023, the stream is at ambient temperature and is assumed to be in standard conditions.
Bark Cyclone Exhaust Flow Rate	8,564	scfm	Per Table 3.0 in the TSD for 12AOP915 (Cyclone #11). The stream is assumed to be at ambient conditions.
Dry Chip Cyclone Exhaust Flow Rate	5,150	scfm	Per Table 3.0 in the TSD for 12AOP915 (Cyclone #21). The stream is assumed to be at ambient conditions.
Dry Chip Baghouse Control Efficiency	99%	--	Based on the 2021 ORCAA AEI workbook, baghouses are assumed to maintain a control efficiency of 99%.
Cyclone PM Grain Loading Rate	0.03	gr/dscf	Based on the 2021 ORCAA AEI workbook, the PM grain loading rate comes from FIRE 6.23 October 2000, SCC 30700804, 30700805, which is also in Table 10.4.1 AP-42, p. 10.4-2 (2/80).

Table F-12. Cyclones Emissions

Emission Unit	Potential Operation	Exhaust Flow Rate	Loading Rate ¹ (gr./dscf)			Control Efficiency	Filterable PM Emissions ^{2,3}		Filterable PM ₁₀ Emissions ^{2,3}		Filterable PM _{2.5} Emissions ^{2,3}	
	(hr/yr)	(scfm)	PM	PM ₁₀	PM _{2.5}	(%)	(lb/hr)	(tpy)	(lb/hr)	(tpy)	(lb/hr)	(tpy)
Fuel Silo Cyclone	5,200	6,227	0.03	0.012	0.012	0%	1.60	4.16	0.64	1.67	0.64	1.67
Bark Cyclone	5,200	8,564	0.03	0.012	0.012	0%	2.20	5.73	0.88	2.29	0.88	2.29
Dry Chip Cyclone / Baghouse	5,200	5,150	0.03	0.012	0.012	99%	1.32E-02	0.03	5.30E-03	1.38E-02	5.30E-03	1.38E-02
Total:							3.82	9.92	1.53	3.97	1.53	3.97

¹ Based on the 2021 ORCAA AEI workbook, the FIRE 6.23 October 2000, SCC 30700804, 30700805 and EPA factor book 450/4-90-003 p. 144 assume that Filterable PM₁₀ is approximately equal to 40% of Filterable PM. It is also conservatively assumed that Filterable PM₁₀ = Filterable PM_{2.5}. As this source does not involve combustion units, it is assumed that condensable emissions are negligible.

² As a conservative measure, emissions of PM_{2.5} are assumed to be equal to emissions of PM₁₀.

³ Potential hourly PM emissions (lb/hr) = Exhaust Grain Loading Rate (gr./dscf) x Exhaust Air Flow Rate (dscf/min) x (60 min/hr) x (lb/7,000 gr.) x (100% - Control Efficiency (%)).

Table F-13. Pre-Project Wood Waste Collection (Cyclones) Emissions

Emission Unit	Potential Operation	Exhaust Flow Rate	Loading Rate ¹ (gr./dscf)			Control Efficiency	Filterable PM Emissions ^{2,3}		Filterable PM ₁₀ Emissions ^{2,3}		Filterable PM _{2.5} Emissions ^{2,3}	
	(hr/yr)	(scfm)	PM	PM ₁₀	PM _{2.5}	(%)	(lb/hr)	(tpy)	(lb/hr)	(tpy)	(lb/hr)	(tpy)
Dry Chip Cyclone / Baghouse ⁴	8,760	5,150	0.03	0.012	0.012	99%	1.32E-02	0.06	5.30E-03	0.02	5.30E-03	0.02

¹ Based on the 2021 ORCAA AEI workbook, the FIRE 6.23 October 2000, SCC 30700804, 30700805 and EPA factor book 450/4-90-003 p. 144 assume that Filterable PM₁₀ is approximately equal to 40% of Filterable PM. It is also conservatively assumed that Filterable PM₁₀ = Filterable PM_{2.5}. As this source does not involve combustion units, it is assumed that condensable emissions are negligible.

² As a conservative measure, emissions of PM_{2.5} are assumed to be equal to emissions of PM₁₀.

³ Potential hourly PM emissions (lb/hr) = Exhaust Grain Loading Rate (gr./dscf) x Exhaust Air Flow Rate (dscf/min) x (60 min/hr) x (lb/7,000 gr.) x (100% - Control Efficiency (%)).

⁴ Parameters for the existing emission unit based on Table 4.2 in the TSD for 12AOP915. PTE was calculated assuming 8,760 hour/year operation.

Table F-14. Pre- and Post-Project Wood Waste Collection (Cyclones) Emission Comparison

Emission Unit	PTE Emissions ¹ (tpy)		
	PM	PM ₁₀	PM _{2.5}
Pre-Project Wood Waste Collection			
Dry Chip Cyclone / Baghouse	0.06	0.02	0.02
All Other Existing Cyclones	1.64	0.68	0.68
<i>Pre-Project Total:</i>	1.7	0.7	0.7
Post-Project Wood Waste Collection			
Dry Chip Cyclone / Baghouse	0.03	1.38E-02	1.38E-02
All Other Existing Cyclones	1.64	0.68	0.68
Fuel Silo Cyclone	4.16	1.67	1.67
Bark Cyclone	5.73	2.29	2.29
<i>Post-Project Total:</i>	11.57	4.65	4.65

¹ Parameters for existing emission units based on Table 4.2 in the TSD for 12AOP915. PM Emissions were estimated using methods presented in ORCAA's 2021 AEI workbook.

Table F-15. Haul Roads Input Parameters

Vehicle Name	Class	Vehicle Weight (Avg of Loaded + Unloaded) (tons)	Number of Trips per Day	Number of Days per Week	Number of Weeks per Year	Miles Round Trip (Paved)	Vehicle Miles Traveled per Day (VMT/day)	Vehicle Miles Traveled per Year (VMT/yr)
Chip	Trucks	34	12	5	52	0.5	6	1560
Sawdust	Trucks	34	0	0	52	0.5	0	0
Lumber	Trucks	26	16	5	52	0.5	8	2080
Hog Fuel	Trucks	34	8	6	52	0.5	4	1248
Production Stackers	Stacker	75	75	6	52	0.1	7.5	2340
Production Forklifts	Forklifts	15	380	5	52	0.1	38	9880
Co. Pickups	Co. Pickups	2.5	8	6	52	0.5	4	1248
Sales/Service	Vendor	2.5	3	5	52	0.1	0.3	78
Shavings	Trucks	34	2	6	52	1	2	624
On-site transfers	Trucks	26	1	5	52	0.5	0.5	130
Log Delivery	Trucks	26	95	5	52	0.2	19	4940
Total:							89.3	24128

Table F-16. Haul Roads Emissions

Vehicle Name	Weight (tons)	Vehicle Miles Traveled per Year (VMT/yr)	Vehicle Miles Traveled per Day (VMT/day)	Emission Factor, E ¹ (lb/VMT)			Annual Controlled Emissions ² (tpy)			Daily Controlled Emissions ³ (lb/day)		
				PM	PM ₁₀	PM _{2.5}	PM	PM ₁₀	PM _{2.5}	PM	PM ₁₀	PM _{2.5}
Chip	34	1,560	6	0.44	0.09	0.02	0.08	0.02	3.73E-03	0.66	0.13	0.03
Sawdust	34	0	0	0.44	0.09	0.02	0	0	0	0	0	0
Lumber	26	2,080	8	0.33	0.07	0.02	0.08	0.02	3.78E-03	0.67	0.13	0.03
Hog Fuel	34	1,248	4	0.44	0.09	0.02	0.06	1.21E-02	2.98E-03	0.44	0.09	0.02
Production Stackers	75	2,340	8	0.98	0.20	0.05	0.26	0.05	1.25E-02	1.84	0.37	0.09
Production Forklifts	15	9,880	38	0.19	0.04	0.01	0.21	0.04	1.02E-02	1.80	0.36	0.09
Co. Pickups	2.5	1,248	4	0.03	0.01	0.00	4.24E-03	8.48E-04	2.08E-04	0.03	6.11E-03	1.50E-03
Sales/Service	2.5	78	0	0.03	0.01	0.00	2.65E-04	5.30E-05	1.30E-05	2.29E-03	4.58E-04	1.12E-04
Shavings	34	624	2	0.44	0.09	0.02	0.03	6.07E-03	1.49E-03	0.22	0.04	1.07E-02
On-site transfers	26	130	1	0.33	0.07	0.02	4.81E-03	9.62E-04	2.36E-04	0.04	8.32E-03	2.04E-03
Log Delivery	26	4,940	19	0.33	0.07	0.02	0.18	0.04	8.97E-03	1.58	0.32	0.08
Total:							0.90	0.18	0.04	7.28	1.46	0.36

¹ Emission factor E is calculated according to AP-42 Section 13.2.1 for emissions from paved roads, equation 1:

$$E \text{ (lbs/VMT)} = \text{Paved Road Emission Factor, } [k * (sL)^{0.91} * (W)^{1.02}]$$

0.011 = k, PM size multiplier (lb/VMT) from AP-42 Table 13.2.1-1.

0.0022 = k, PM₁₀ size multiplier (lb/VMT) from AP-42 Table 13.2.1-1.

0.00054 = k, PM_{2.5} size multiplier (lb/VMT) from AP-42 Table 13.2.1-1.

1.1 = sL, roadway surface silt loading (g/m²) AP-42 13.2.1, Table 13-2.1-3. The average silt loading value for corn wet mills is used because the sawmill is expected to store materials with a similar texture and moisture content.

² Emissions account for natural mitigation due to precipitation according to AP-42 Section 13.2.1 equation 2:

$$\text{Annual emissions (tpy)} = E * (1-P/4N) * (1-C) * [\text{VMT/yr}] / [\text{lb/ton}]$$

161.6 = P, mean number of days per year with measurable precipitation from Western Regional Climatological Center, Olympia, WA station.

365 = N, number of days in period for annual rainfall mitigation effect

75% = C, control efficiency applied for watering and sweeping.

Paved roads are watered and vacuumed quarterly as control measures. Control efficiency from ORCAA's AEI workbook.

³ Daily emissions (lb/day) are calculated in the same manner as annual emissions, but with the daily Vehicle Miles Traveled per Day and not taking credits for precipitation.

APPENDIX G. MODEL PARAMETERS

Table G-1. Rectangular Buildings

ID	Description	X Coordinate (m)	Y Coordinate (m)	Elevation (m)	Height (m)	X Length (m)	Y Length (m)	Angle degree
BLDG_1	Planer Building	443426.8	5171013.2	3.92	18.29	138.1	27.7	90
BLDG_3	Large Dry Storage Building	443511.3	5170944.8	4.01	18.29	299.4	29.5	90
BLDG_4	Small Dry Storage Building	443541.1	5170945.1	4.10	18.29	62.1	29.8	90
BLDG_5	Trimmer Sorter Stacker Building	443571.2	5171006.3	4.07	18.29	159.2	30.7	90
BLDG_6	Sawmill Building	443602	5170896.9	4.25	13.72	28.2	80.4	90
BLDG_7	Sawmill Building_2	443602.6	5170868.2	4.19	13.72	20.7	22.7	90
CDK	CDK Building	443483	5170784.1	3.50	11.34	108.7	14.8	90
BURNER	CDK Burner	443473.3	5170756.7	3.48	24.97	11.5	6.7	90

¹ Building elevations determined by AERMAP preprocessor.

Table G-2. Circular Buildings

ID	Description	X Coordinate (m)	Y Coordinate (m)	Elevation (m)	Height (m)	Radius (m)	Corners
F_SILO	Green Sawdust Silo	443469.2	5170778.2	3.65	25.60	6.10	24

¹ Building elevations determined by AERMAP preprocessor.

Table G-3. Polygon Buildings

ID	Description	X Coordinate (m)	Y Coordinate (m)	Elevation m	Height m
BLDG_2	Planer Infeed Building	443455.3	5171026.3	4.13	12.19

¹ Building elevations determined by AERMAP preprocessor.

Table G-4. Point Sources

ID	Description	X Coordinate (m)	Y Coordinate (m)	Elevation ³ (m)	Stack Height ² (m)	Stack Temp (K)	Exit Vel. (m/s)	Stack Diam. (m)
CDK_S	CDK South Merged Stack ¹	443492.7	5170676.4	3.31	13.47	333.15	21.75	1.18
CDK_N	CDK North Merged Stack ¹	443485.6	5170783.2	3.48	13.47	333.15	21.75	1.18
C_FS	Fuel Silo Cyclone	443469.3	5170777.8	3.65	34.75	0.00	7.64	0.70
C_B	Bark Cyclone	443754.9	5170852.1	3.75	11.58	0.00	5.12	1.00
BAG2	Baghouse #2 - Carter Day	443417.1	5170941.8	4.14	9.14	0.00	22.85	1.00
BAG_BS	Band Saw Filing Room Baghouse	443628.5	5170906.2	4.29	3.30	0.00	21.83	0.406

¹ Because the stacks at each end of the CDK are located less than one stack diameter from each other, are similar in height, have the same exhaust flowrate and temperature, and have the same source of emissions, they are modeled in total as two merged stacks based on guidance from "Practical Guide to Atmospheric Dispersion Modeling" (Turner and Schulze).

Exhaust data obtained from email from IDS Windsor on 3/28/2023 and engineering drawings of the CDK (March 29, 2023).

Flowrate per singular stack:	25,000 acfm	or	11.80	m ³ /s
Flowrate per merged stack:	50,000 acfm	or	23.60	m ³ /s
Temperature:	140 F			
Diameter per singular stack:	0.83 m			
Velocity per singular stack:	21.75 m/s			

² Based on engineering drawings of the CDK (March 29, 2023), the stacks have a less than 1.5 ft difference in height. The lower stack height is used as the height of the merged stack for conservatism. Existing unit stack heights are based on measurement and site documentation.

³ Source elevation determined by AERMAP preprocessor.

⁴ Velocity for existing units is determined by exhaust flowrate as defined in 12AOP915 TSD (11/20/19).

⁵ Stack diameter for existing units is determined by measurement.

Table G-5. Horizontal Point Sources

ID	Description	X Coordinate (m)	Y Coordinate (m)	Elevation (m)	Stack Height (m)	Stack Temp (K)	Exit Vel. (m/s)	Stack Diam. (m)
BAG1	Baghouse #1 - Clark	443417.6	5170935.9	4.19	9.14	0.00	16.51	1.54
BAG3	Baghouse#3 - Package Saw Shaker	443503.0	5170839.6	3.71	4.27	0.00	11.85	0.42
BAG_SM	Sawmill Baghouse	443661.0	5170864.3	4.31	11.58	0.00	23.81	1.06
BAG_P	Powerhouse Baghouse	443326.2	5170837.4	3.76	9.14	0.00	13.20	0.84
BAG_DC	Dry Chips Baghouse	443671.4	5170864.2	4.16	4.52	0.00	18.47	1.14

¹ Source elevation determined by AERMAP preprocessor.

² Velocity for existing units is determined by exhaust flowrate as defined in 12AOP915 TSD (11/20/19).

³ Stack diameter for existing units is determined by measurement.

⁴ Existing unit stack heights are based on measurement and site documentation.

⁵ Dry Chip Baghouse exhaust parameters are determined by engineering drawings from Superior Systems.

Table G-6. Volume Sources

ID	Description	X Coordinate (m)	Y Coordinate (m)	Elevation (m)	Release Height (m)	Init. Lat. Dim. (m)	Init. Vert. Dim. (m)
GSD	Green sawdust sawmill drop	443614.2	5170857.3	4.23	6.86	4.81	6.38
DB	Log Debarking	443742.9	5170872.8	4.16	6.86	1.98	6.38
CBL	Chip bin truck loadout	443699.9	5170851.6	3.74	7.24	1.23	6.73
BBL	Bark bin truck loadout	443758.9	5170852.1	3.75	7.24	1.23	6.73

¹ Volume source dimensions for truck loadout determined using dimensions of the storage bins:

Bin height:	14.48	m
Bin width:	5.28	m

Table G-7. Point Source - Criteria Pollutant Emission Rates

Source	Model ID	Emission Rate (g/s)						
		PM ₁₀ 24-hr	24-hr	PM _{2.5} Annual	CO 1-hr/8-hr	NO ₂ 1-hr	NO ₂ Annual	SO ₂ 1-hr
CDK South Merged Stack	CDK_S	2.42E-01	2.30E-01	2.21E-01	1.70E+00	6.51E-01	6.24E-01	7.87E-02
CDK North Merged Stack	CDK_N	2.42E-01	2.30E-01	2.21E-01	1.70E+00	6.51E-01	6.24E-01	7.87E-02
Fuel Silo Cyclone	C_FS	8.07E-02	8.07E-02	4.79E-02	--	--	--	--
Bark Cyclone	C_B	1.11E-01	1.11E-01	6.59E-02	--	--	--	--
Baghouse #2 - Carter Day	BAG2	1.75E-03	1.75E-03	1.75E-03	--	--	--	--
Band Saw Filing Room Baghouse	BAG_BS	7.75E-04	7.75E-04	7.75E-04	--	--	--	--

Table G-8. Horizontal Point Source - Criteria Pollutant Emission Rates

Source	Model ID	Emission Rate (g/s)		
		PM ₁₀ 24-hr	24-hr	PM _{2.5} Annual
Baghouse #1 - Clark	BAG1	8.40E-03	8.40E-03	8.40E-03
Baghouse#3 - Package Saw Shaker	BAG3	4.52E-04	4.52E-04	4.52E-04
Sawmill Baghouse	BAG_SM	5.78E-03	5.78E-03	5.78E-03
Powerhouse Baghouse	BAG_P	2.60E-03	2.60E-03	2.60E-03
Dry Chips Baghouse	BAG_DC	6.67E-04	6.67E-04	3.96E-04

Table G-9. Volume Source - Criteria Pollutant Emission Rates

Source	Model ID	Emission Rate (g/s)		
		PM ₁₀ 24-hr	24-hr	PM _{2.5} Annual
Green sawdust sawmill drop	GSD	4.33E-03	6.55E-04	4.67E-04
Log Debarking	DB	1.04E-01	1.44E-02	1.44E-02
Chip bin truck loadout	CBL	1.44E-01	2.17E-02	1.55E-02
Bark bin truck loadout	BBL	3.68E-02	5.58E-03	3.97E-03

Table G-10. Volume Source - Vehicle Traffic - Emission Rates

Vehicle Name	Model Route Name	Emission Rate (g/s)			Total Number of Sources	Emission Rate/Source (g/s)			Vehicle Height (m)	Vehicle Width (m)
		PM ₁₀ 24-hr	24-hr	PM _{2.5} Annual		PM ₁₀ 24-hr	24-hr	PM _{2.5} Annual		
Chip	Chip Trucks	6.89E-04	1.69E-04	1.07E-04	40	1.72E-05	4.23E-06	2.68E-06	3	3
Lumber		6.99E-04	1.72E-04	1.09E-04						
Co. Pickups	Shipping Trucks	3.21E-05	7.87E-06	5.98E-06	140	5.55E-06	1.36E-06	8.70E-07	3	3
Sales/Service		2.41E-06	5.90E-07	3.74E-07						
On-site transfers		4.37E-05	1.07E-05	6.79E-06						
Hog Fuel	Bark/Hog Fuel Trucks	4.60E-04	1.13E-04	8.58E-05	33	1.39E-05	3.42E-06	2.60E-06	3	3
Production Stackers	log Stackers	1.93E-03	4.74E-04	3.60E-04	84	2.30E-05	5.64E-06	4.29E-06	4.32	3
Production Forklifts	Green Lumber, Dry Lumber, Planer, shipping forklifts	1.89E-03	4.65E-04	2.95E-04	189	1.00E-05	2.46E-06	1.56E-06	4.32	3
Shavings	Shaving Trucks	2.30E-04	5.64E-05	4.29E-05	158	1.45E-06	3.57E-07	2.71E-07	3	3
Log Delivery	Log Trucks	1.66E-03	4.08E-04	2.58E-04	28	5.93E-05	1.46E-05	9.22E-06	3	3

¹ Forklift dimensions based on vendor specification sheets. Truck dimensions are based on default average truck dimensions from EPA guidance memo on haul roads.

Table G-11. TAP Emission Rates per CDK Stack (g/s)

Pollutant CAS #	Acetaldehyde 75-07-0	Acrolein 107-02-8	Formaldehyde 50-00-0	Sulfur dioxide 7446-09-5
1-hr, 8-hr, 24-hr	6.48E-02	1.98E-03	2.01E-02	7.87E-02
Annual	6.22E-02	1.90E-03	1.93E-02	7.55E-02

¹It is assumed that emissions from the CDK will be split evenly between the four exhaust stacks (two modeled stacks) so emission rates are divided by two.

APPENDIX H. CONCENTRATION PLOTS

Maximum Modeled Acetaldehyde Concentration Annual ASIL 0.37 ($\mu\text{g}/\text{m}^3$)

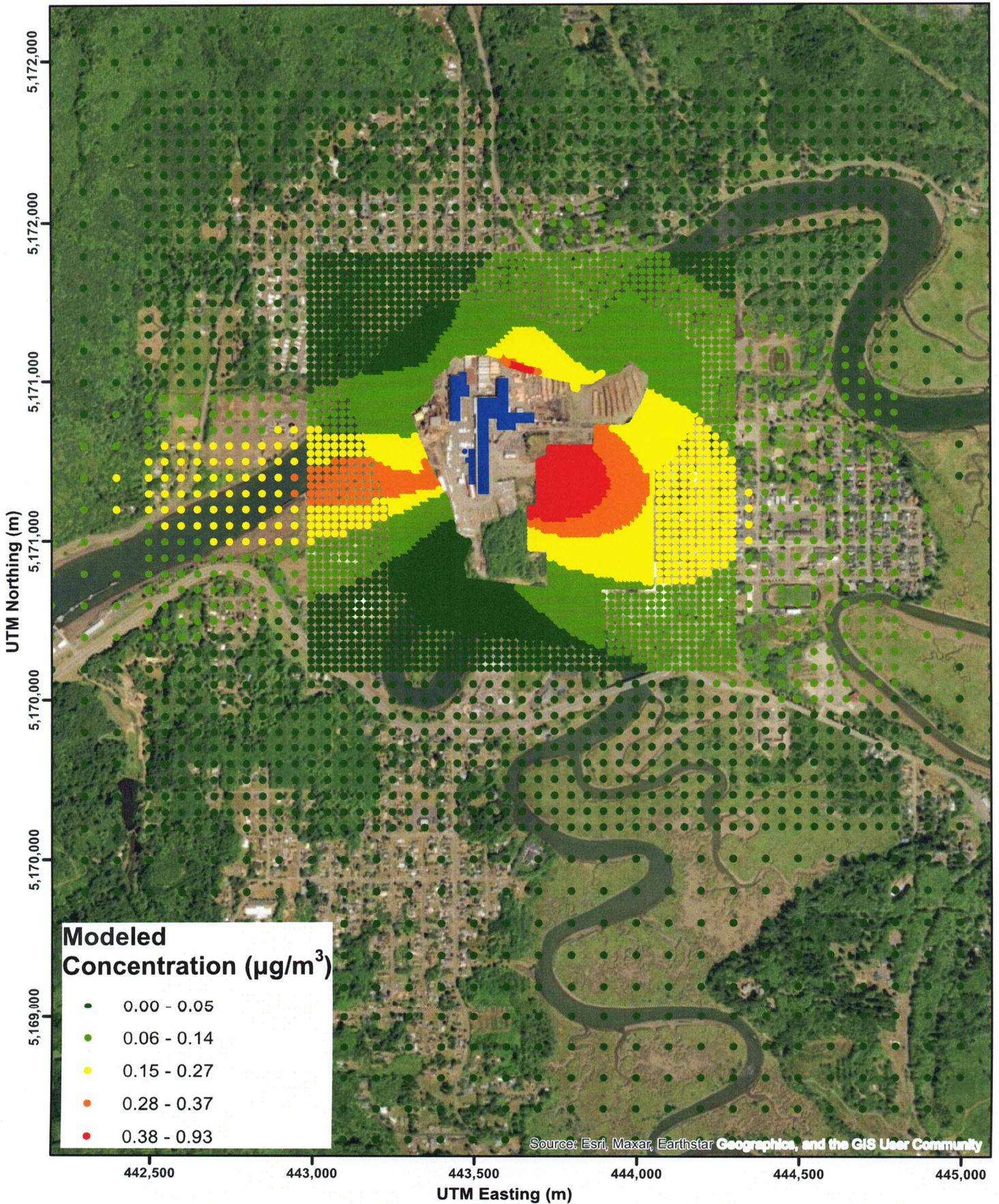

Source: Esri, Maxar, Earthstar Geographics, and the GIS User Community

UTM Easting (m)
All Coordinates shown in UTM Coordinates,
Zone 10, WGS 1984

Maximum Modeled Formaldehyde Concentration Annual ASIL 0.17 ($\mu\text{g}/\text{m}^3$)

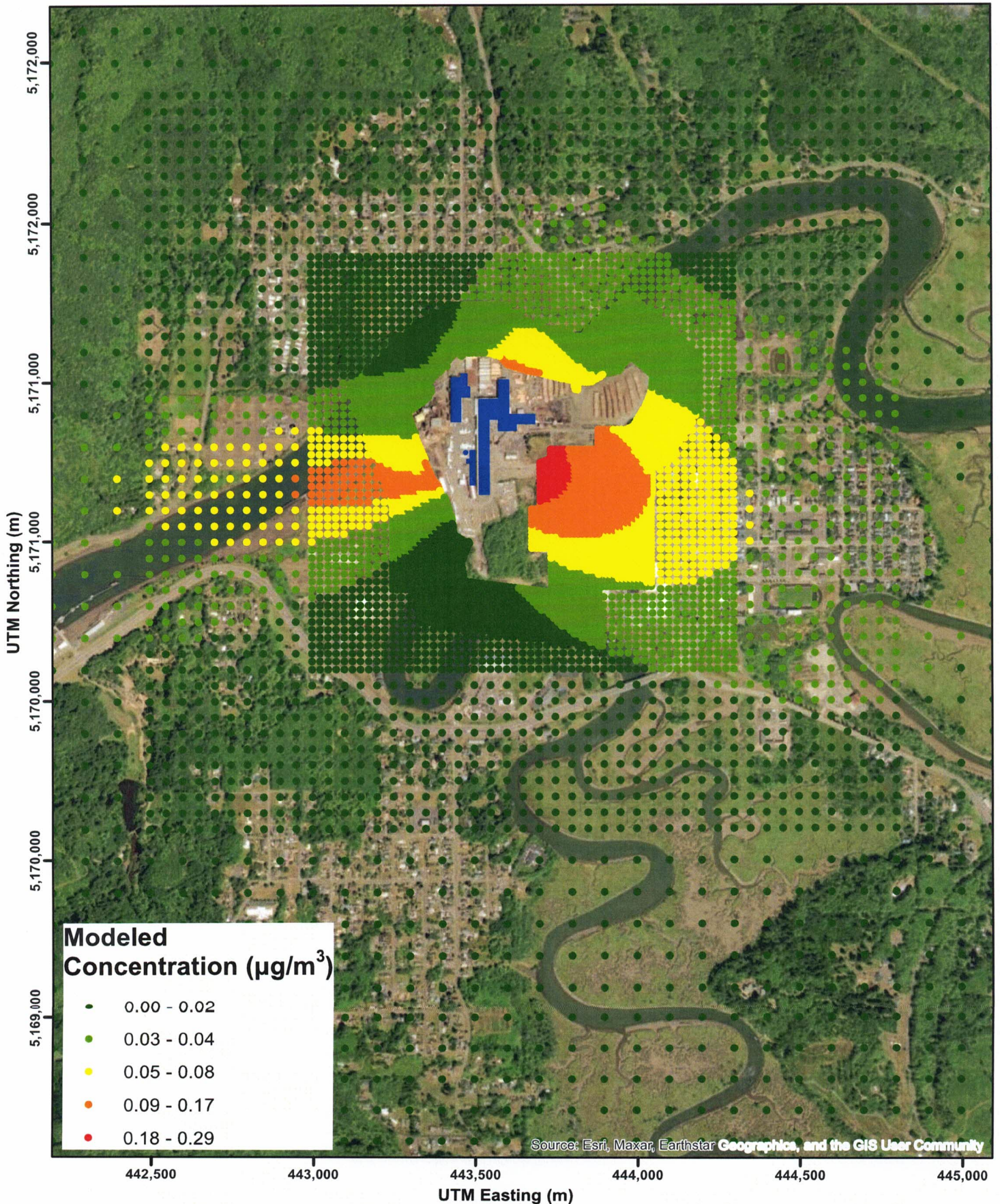

Source: Esri, Maxar, Earthstar Geographics, and the GIS User Community

All Coordinates shown in UTM Coordinates,
Zone 10, WGS 1984

High 6th High Modeled PM₁₀ Concentration 24-hr NAAQS 114 (µg/m³)

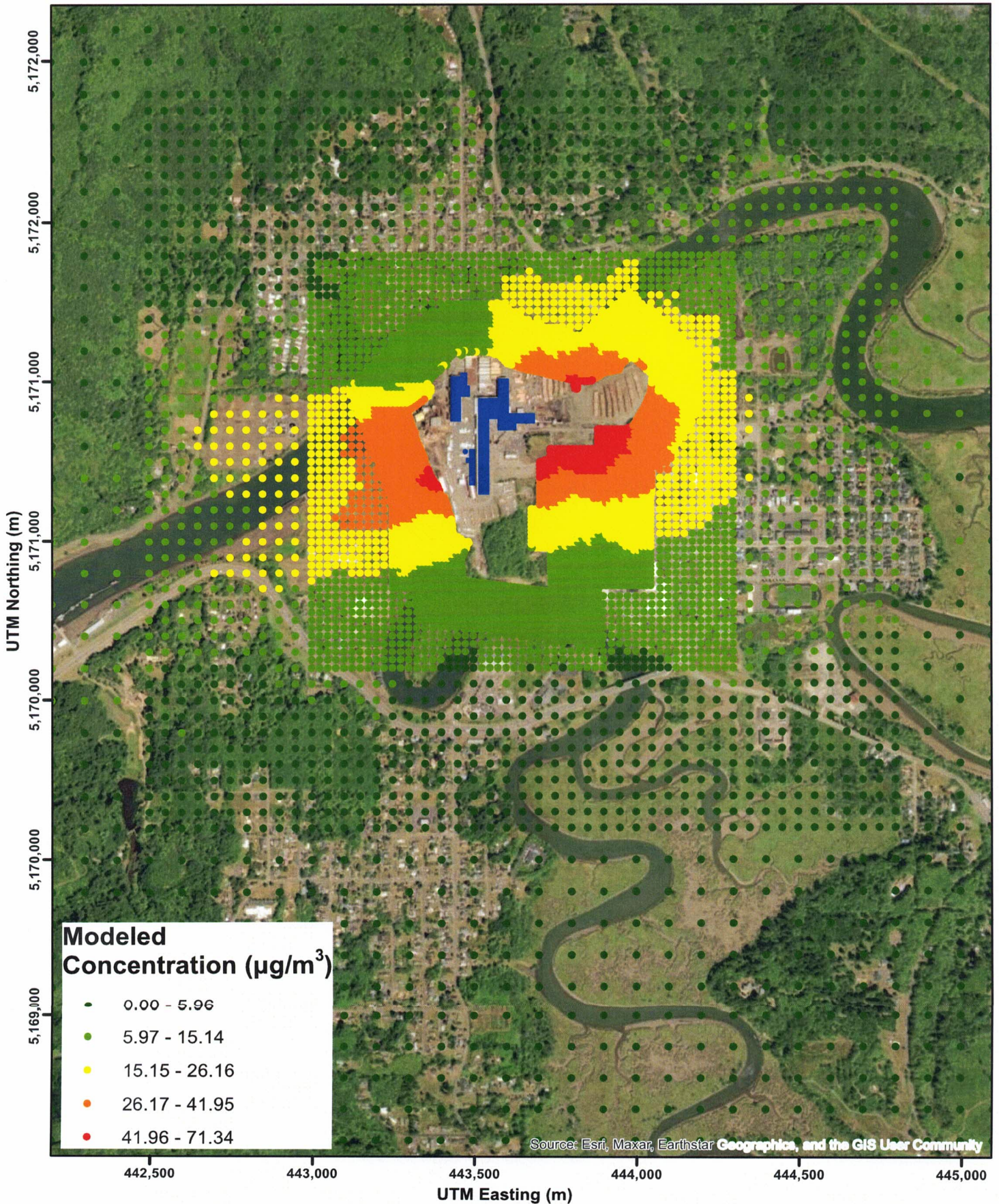

Source: Esri, Maxar, Earthstar Geographics, and the GIS User Community

All Coordinates shown in UTM Coordinates,
Zone 10, WGS 1984

High 8th High Modeled PM_{2.5} Concentration 24-hr NAAQS 35 (µg/m³)

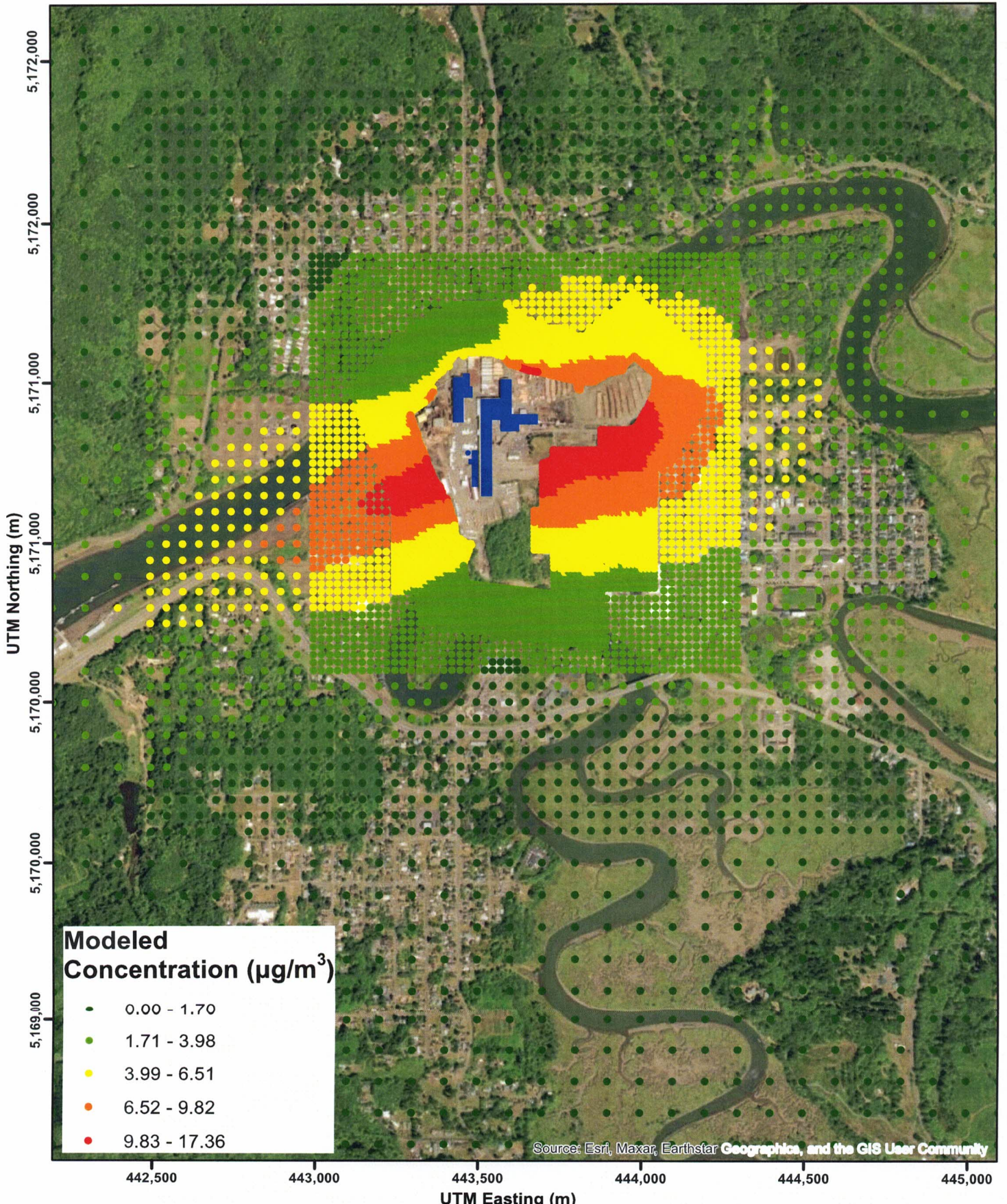

All Coordinates shown in UTM Coordinates,
Zone 10, WGS 1984

Maximum Modeled PM_{2.5} Concentration Annual NAAQS 12 (µg/m³)

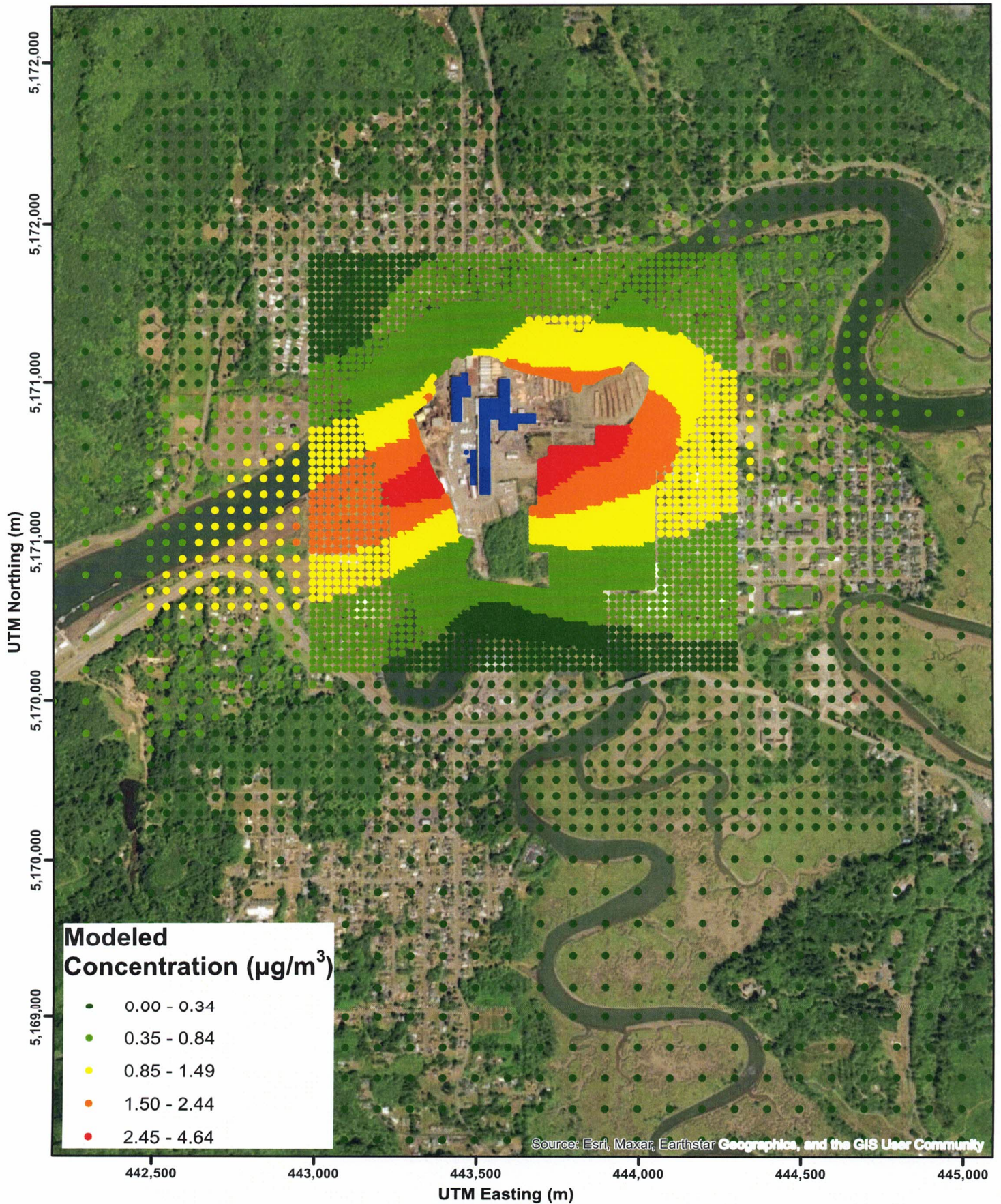

All Coordinates shown in UTM Coordinates,
Zone 10, WGS 1984

High 8th High Modeled NO₂ Concentration 1-hr NAAQS 188 (µg/m³)

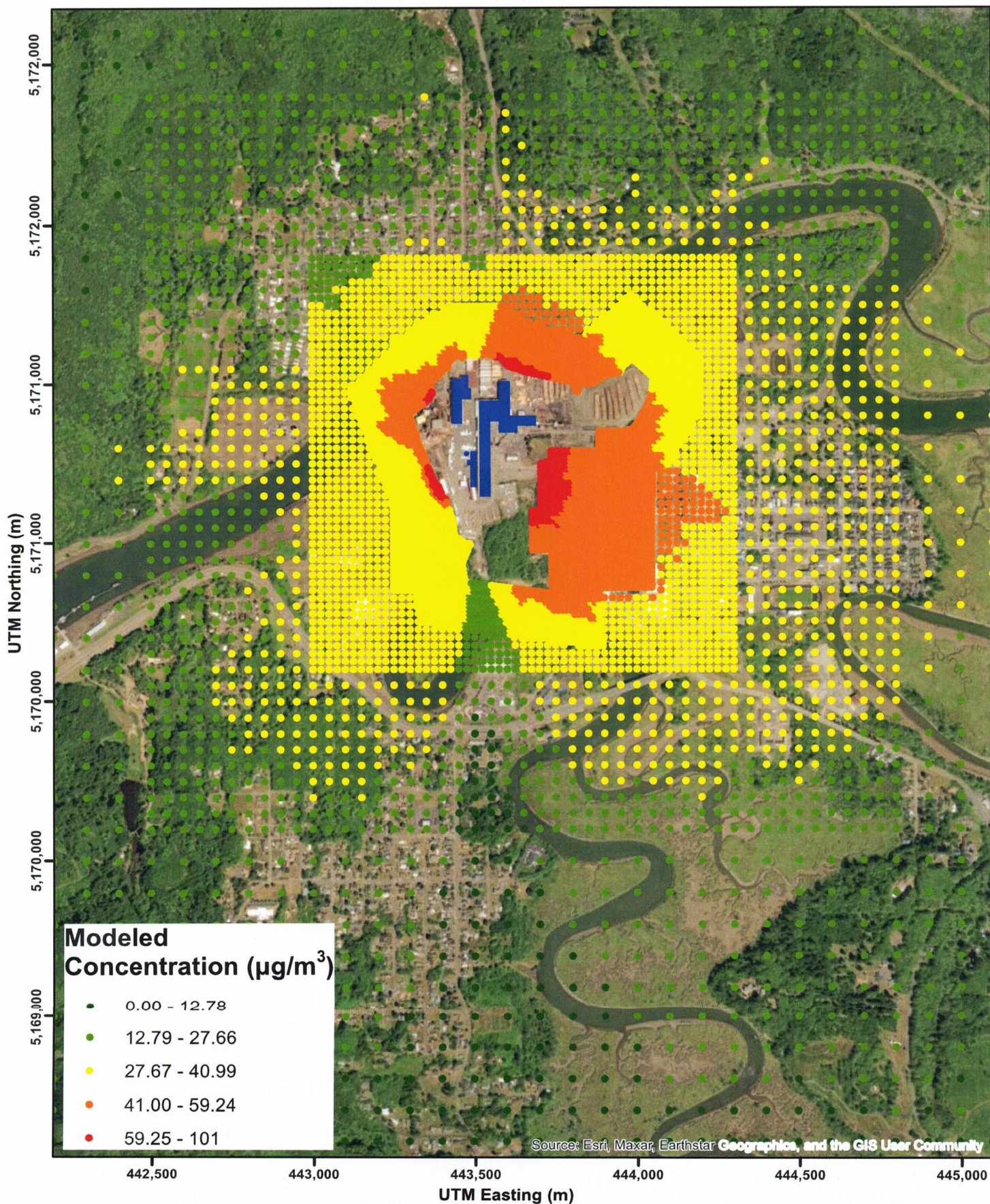

All Coordinates shown in UTM Coordinates,
Zone 10, WGS 1984

Maximum Modeled NO₂ Concentration Annual NAAQS 100 (µg/m³)

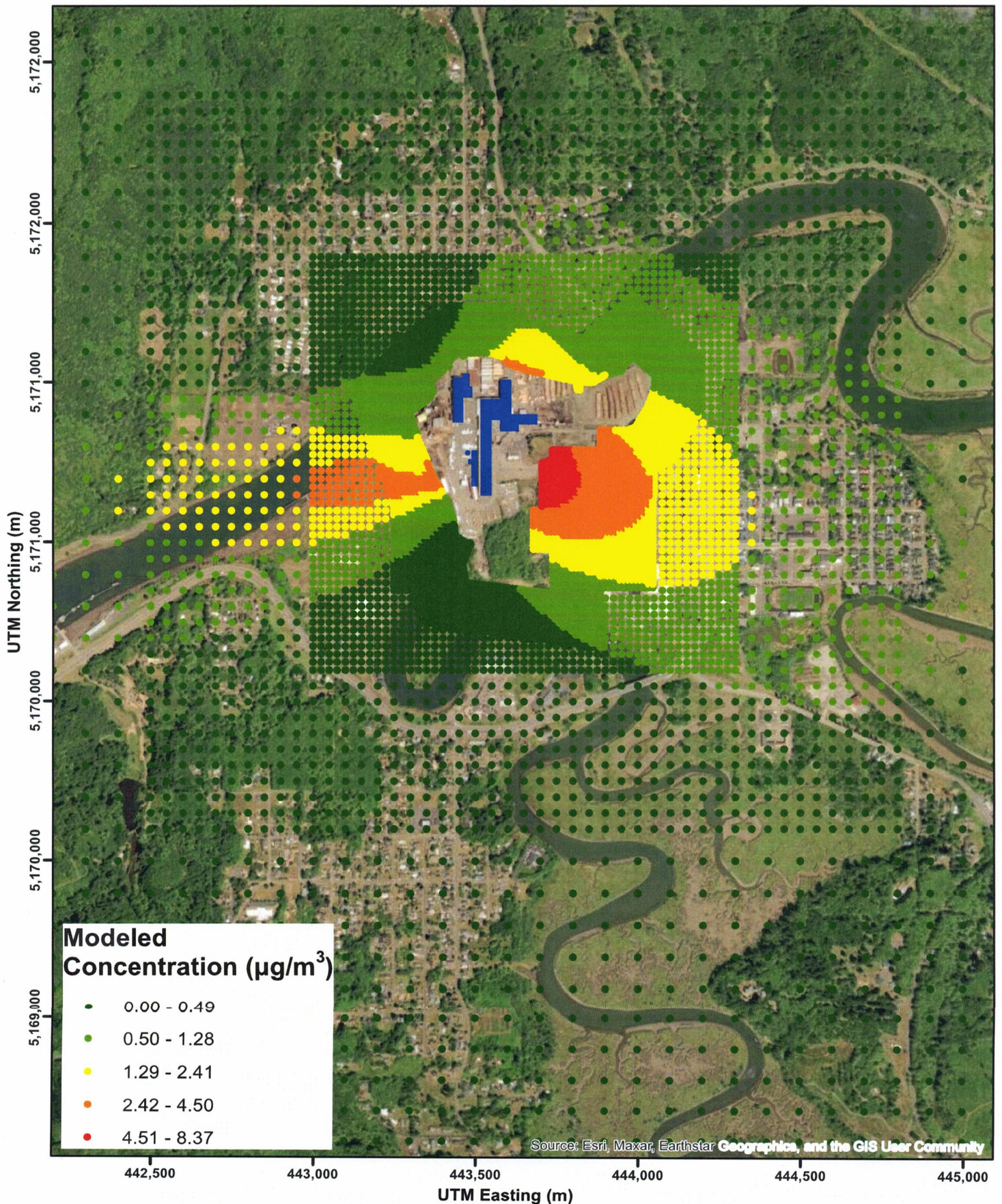

Source: Esri, Maxar, Earthstar Geographics, and the GIS User Community

All Coordinates shown in UTM Coordinates,
Zone 10, WGS 1984

High 4th High Modeled SO₂ Concentration 1-hr NAAQS 196 (µg/m³)

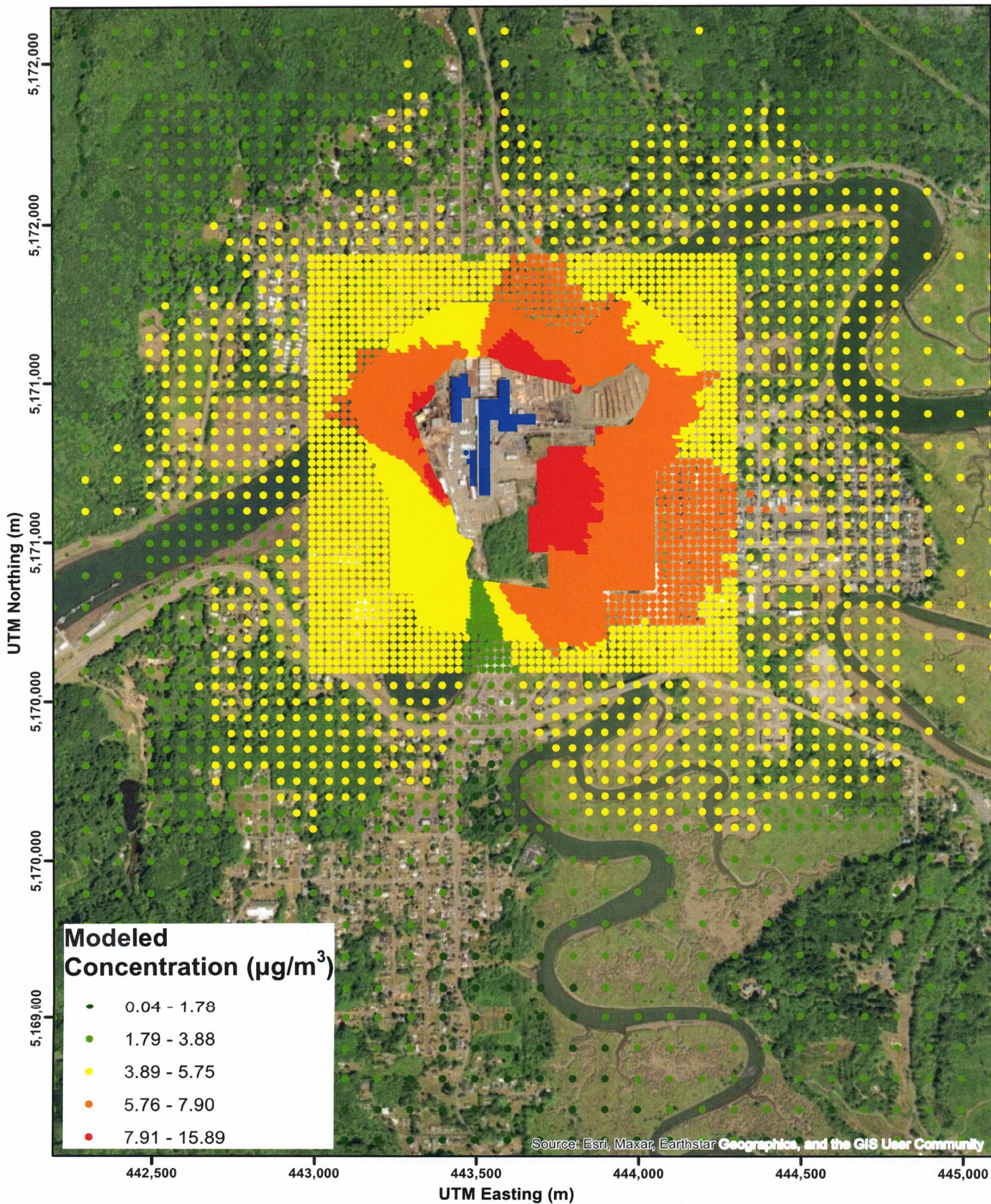

Source: Esri, Maxar, Earthstar Geographics, and the GIS User Community

All Coordinates shown in UTM Coordinates,
Zone 10, WGS 1984

APPENDIX I. MODEL FILES

Model files provided electronically. A directory of files is provided below. Elevation data available upon request.

Appendix Table I-1. AERMOD Run Log

File Name ^a	Pollutant	Averaging Period	Modeled Year(s)	Description
CNEXX	CO	1-hr and 8-hr	2016-2020	Project significant impact modeling – maximum across 5 years
SNE1620	SO ₂	1-hr	2016-2020	NAAQS modeling – maximum (H4H) 5-year average
PM25NE1620	PM _{2.5}	24-hr	2016-2020	NAAQS modeling – maximum (H8H) 5-year average
PM25_Annual_NE1620	PM _{2.5}	Annual	2016-2020	NAAQS modeling – maximum 5-year average
PM10NE1620	PM ₁₀	24-hr	2016-2020	NAAQS modeling – maximum (H2H) across 5 years
NNE1620	NO ₂	1-hr	2016-2020	TAP/NAAQS modeling – maximum (H1H/H8H) 5-year average
NNEXX	NO ₂	Annual	2016-2020	NAAQS modeling – maximum across 5 years
20XX_acetalde_aermod	Acetaldehyde	Annual	2016-2020	TAP modeling – maximum across 5 years
2016_2020_acrolein_aermod	Acrolein	24-hr	2016-2020	TAP modeling – maximum across 5 years
20XX_formalde_aermod	Formaldehyde	Annual	2016-2020	TAP modeling – maximum across 5 years
2016_2020_sulfur_d_aermod	SO ₂	1-hr	2016-2020	TAP modeling – maximum across 5 years
HQM16-20	--	--	2016-2020	Surface and Upper Air Meteorological Data
BPIP input/output file	--	--	--	BPIP preprocessor files

a. File names with "XX" denote multiple files for a single pollutant. "XX" represents the modeled meteorological year.

SEPA ENVIRONMENTAL CHECKLIST

Purpose of checklist

Governmental agencies use this checklist to help determine whether the environmental impacts of your proposal are significant. This information is also helpful to determine if available avoidance, minimization, or compensatory mitigation measures will address the probable significant impacts or if an environmental impact statement will be prepared to further analyze the proposal.

Instructions for applicants

This environmental checklist asks you to describe some basic information about your proposal. Please answer each question accurately and carefully, to the best of your knowledge. You may need to consult with an agency specialist or private consultant for some questions. **You may use “not applicable” or “does not apply” only when you can explain why it does not apply and not when the answer is unknown.** You may also attach or incorporate by reference additional studies reports. Complete and accurate answers to these questions often avoid delays with the SEPA process as well as later in the decision-making process.

The checklist questions apply to **all parts of your proposal**, even if you plan to do them over a period of time or on different parcels of land. Attach any additional information that will help describe your proposal or its environmental effects. The agency to which you submit this checklist may ask you to explain your answers or provide additional information reasonably related to determining if there may be significant adverse impact.

Instructions for lead agencies

Please adjust the format of this template as needed. Additional information may be necessary to evaluate the existing environment, all interrelated aspects of the proposal and an analysis of adverse impacts. The checklist is considered the first but not necessarily the only source of information needed to make an adequate threshold determination. Once a threshold determination is made, the lead agency is responsible for the completeness and accuracy of the checklist and other supporting documents.

Use of checklist for nonproject proposals

For nonproject proposals (such as ordinances, regulations, plans and programs), complete the applicable parts of sections A and B, plus the [Supplemental Sheet for Nonproject Actions \(Part D\)](#). Please completely answer all questions that apply and note that the words "project," "applicant," and "property or site" should be read as "proposal," "proponent," and "affected geographic area," respectively. The lead agency may exclude (for non-projects) questions in “Part B: Environmental Elements” that do not contribute meaningfully to the analysis of the proposal.

A. Background [Find help answering background questions](#)

1. Name of proposed project, if applicable:

Raymond Lumbermill Plant Modernization

2. Name of applicant:

Weyerhaeuser NR Company

3. Address and phone number of applicant and contact person:

Weyerhaeuser Raymond Lumbermill
 51 Ellis St., Raymond, WA 98577-1740
 Attn: Ms. Angela Cameron
 (360) 749-3225

4. Date checklist prepared:

September 5, 2023

5. Agency requesting checklist:

Washington State Department of Ecology (Ecology)
 City of Raymond

6. Proposed timing or schedule (including phasing, if applicable):

2023 – Q3	Complete engineering for CDK system and related facility improvements, permitting, fabricated equipment procurement, construction preparation, storeroom construction
2023 – Q4	Underground construction
2024 – Q1	Foundations & piling construction
2024 – Q2	Structural steel construction
2024 – Q3	Equipment placement, buildings construction & electrical wiring
2024 – Q4	Commissioning and startup of CDK system.
2025 – Q1	Decommission batch kilns, cooling shed, storage shed, bins, hog fuel building, and powerhouse when target production rate is achieved.

7. Do you have any plans for future additions, expansion, or further activity related to or connected with this proposal? If yes, explain.

No

8. List any environmental information you know about that has been prepared, or will be prepared, directly related to this proposal.

The facility stormwater pollution prevention plan (SWPPP) will be updated with the stormwater conveyance and treatment improvements associated with the CDK project. The spill prevention control and countermeasures (SPCC) plan for the facility will be updated. The wastewater slug discharge control plan will be updated to include the CDK condensate pretreatment process and associated water quality control features.

9. Do you know whether applications are pending for governmental approvals of other proposals directly affecting the property covered by your proposal? If yes, explain.

A Notice of Intent (NOI) application for coverage under the Construction Stormwater General Permit is pending with Washington State Department of Ecology.

A Notice of Construction (NOC) permit application for an air discharge permit has been submitted to the Olympic Region Clean Air Agency

10. List any government approvals or permits that will be needed for your proposal, if known.

In addition to the permits identified above in item 9, a state waste discharge permit application will be submitted to Ecology for a modified permit to discharge industrial wastewater to the City of Raymond Sanitary Sewer. Also, a City of Raymond Shoreline Development Application will be submitted.

11. Give a brief, complete description of your proposal, including the proposed uses and the size of the project and site. There are several questions later in this checklist that ask you to describe certain aspects of your proposal. You do not need to repeat those answers on this page. (Lead agencies may modify this form to include additional specific information on project description.)

Weyerhaeuser is proposing to install a new continuous dry kiln (CDK) system that will have the capacity to process 300 million board feet per year of Douglas Fir green lumber. The CDK system will replace the existing batch kilns. The project will also include redeveloping portions of the facility to properly accommodate the changes to the lumber processing operations. Other improvements will include newly paved or repaved surfaces, new stormwater drainage and conveyance features, and new stormwater treatment components. There will be an increase in the daily volume of condensate generated by the new CDK system, and a new pretreatment system will be installed for pretreatment of that wastewater before discharge to the City of Raymond sanitary sewer and publicly owned treatment works (POTW).

12. Location of the proposal. Give sufficient information for a person to understand the precise location of your proposed project, including a street address, if any, and section, township, and range, if known. If a proposal would occur over a range of area, provide the range or boundaries of the site(s). Provide a legal description, site plan, vicinity map, and topographic map, if reasonably available. While you should submit any plans required by the agency, you are not required to duplicate maps or detailed plans submitted with any permit applications related to this checklist.

The Weyerhaeuser Raymond Lumbermill is located at 51 Ellis St. in the City of Raymond, Washington, at the confluence of the Willapa River and South Fork tributary, in Pacific County, within parcel no. 14092411009, in Township 14 N, Range 9 W, Section 24, and Township 14 N, Range 8 W, Section 19. The lumbermill covers about 65 acres.

Legal Description of all Weyerhaeuser lots associated with parcel 14092411009: 140924 009 R; RAYMOND MILLSITE view legal field for parcels included TX 31,42 +VAC ST;TX 2-85-93-96-99-A-B 19-14-8; LOT 16 W HWY 140819 ; TX 112 W HWY 140819; 103 W HWY 140819;RAYMOND BLK 1 LOTS 4,5,9-13; BLK 2 LOT 12; BLK 3 LOT 1; BLK 7 LOT 1 E70', W40' LOT 1, N40' LOT 2, LOT 2 S10',N20' LOT 3; LOT 3 S30', LOTS 4-13; BLK 8 W1/2 LOT 1, E1/2 LOT 1,2,N1/2 3, W35' OF S1/2 LOT 3, E75' OF S1/2 LOT 3,LOT 9 LS ELY PORT,LOTS 10-12, 19' LOT 13; N31 OF S4' LOT 14, N46' LOT 14; BLK 16 LOTS 9-11, E50' LOT 12; W60' LOT 12---PLUS ALL VAC STREETS & ALLEYS

B. Environmental Elements

1. Earth [Find help answering earth questions](#)

a. General description of the site:

The site topography is generally level at approximately elevation +14 feet with a gradual slope toward the Willapa River to the north. The existing ground surface elevations at the site reflect an altered topography due to placement of approximately 3 to 5 feet of hydraulic fill in 1953¹ and additional fill placed more recently to support newer buildings and operations.

Circle or highlight one: **Flat**, rolling, hilly, steep slopes, mountainous, other:

b. What is the steepest slope on the site (approximate percent slope)?

The site is generally flat with less than 1% slope (excluding the immediate shoreline where the slope can be a bit larger)

What general types of soils are found on the site (for example, clay, sand, gravel, peat, muck)? If you know the classification of agricultural soils, specify them, and note any agricultural land of long-term commercial significance and whether the proposal results in removing any of these soils.

No agricultural soils are present. Soils in the lumbermill area, including the Project location, are mapped as Udorthents (147), which are described as being moderately well drained, having a shallow depth to the water table (2 to 6 feet), a high capacity to transmit water, and a deep restrictive layer.²

c. Are there surface indications or history of unstable soils in the immediate vicinity? If so, describe.

No indications of current or historic unstable soils have been observed; however, the site consists of fill placed on alluvial soils at the confluence of the Willapa River mainstem and South Fork. The site is within a larger geologic unit described as Quaternary unconsolidated or semi-consolidated alluvial clay, silt, sand, gravel, and (or) cobble deposits; locally includes peat, muck, and diatomite; locally includes beach, dune, lacustrine, estuarine, marsh, landslide, lahar, glacial, or colluvial deposits; locally includes volcanoclastic or tephra deposits; locally includes modified land and artificial fill. Liquefaction susceptibility is moderate to high; the National Earthquake Hazards Reduction Program (NEHRP) Seismic Class is "D-E", and the seismic design category is "D1" (using site class mapping) and "D2" (assuming site class D).³

¹ Hart-Crowser & Associates. 1979. Subsurface exploration and geotechnical engineering study, proposed Weyerhaeuser Sawmill, Willapa Branch, Raymond, Washington. Project reference number J-846. 24 pp + appendices.

² US Department of Agriculture- Natural Resources Conservation Service, Web Soil Survey at <http://websoilsurvey.nrcs.usda.gov/app/WebSoilSurvey.aspx> accessed 2013 and April 2021.

³ Washington Geologic Information Portal Ground Response map accessed 06-17-21 at [https://geologyportal.dnr.wa.gov/2d-view#natural_hazards?-13786126,-13761666,5884302,5900851?Surface_Geology,500k_Surface_Geology,Geologic_Units_500K,Earthquakes,Ground_Response,Seismic_Design_Categories_\(Using_Site_Class_Mapping\),Seism](https://geologyportal.dnr.wa.gov/2d-view#natural_hazards?-13786126,-13761666,5884302,5900851?Surface_Geology,500k_Surface_Geology,Geologic_Units_500K,Earthquakes,Ground_Response,Seismic_Design_Categories_(Using_Site_Class_Mapping),Seism)

d. Describe the purpose, type, total area, and approximate quantities and total affected area of any filling, excavation, and grading proposed. Indicate source of fill.

Structural fill will be imported for approximately 65,000 square feet of new building structures. It is estimated that approximately 20,000 cubic yards of excavated material will be disposed offsite and 25,000 cubic yards of fill will be imported. No re-grading of the site is proposed. The contractor will provide a submittal of their proposed source(s) of fill, and Weyerhaeuser will verify that the fill source meets the design specifications for clean suitable structural fill. Excavated material will be separated and re-used. Rock will be sourced from a local rock and gravel distributor.

e. Could erosion occur because of clearing, construction, or use? If so, generally describe.

Yes, there is potential for erosion because of planned clearing, soil exposure/disturbance, and construction of new pavement. See below for planned control measures.

f. About what percent of the site will be covered with impervious surfaces after project construction (for example, asphalt or buildings)?

Approximately 83 percent of the site will be covered with buildings and impervious pavement/surfaces after project construction.

g. Proposed measures to reduce or control erosion, or other impacts to the earth, if any.

The proposed measure for reducing/controlling erosion will be detailed on the temporary erosion and sediment control (TESC) plans. The work will be performed under the Construction Stormwater General Permit (CSGP), and a construction stormwater pollution prevention plan (SWPPP) is being developed as a requirement of CSGP coverage. The CSGP also requires ongoing stormwater turbidity measurements, comparison to the benchmark, response actions if necessary, discharge monitoring report submittals, and final site stabilization before that permit can be terminated.

2. Air [Find help answering air questions](#)

a. What types of emissions to the air would result from the proposal during construction, operation, and maintenance when the project is completed? If any, generally describe and give approximate quantities if known.

Pollutants emitted from the Project include particulate matter (PM), particulate matter with an aerodynamic diameter less than 10 micron (PM₁₀), particulate matter with an aerodynamic diameter less than 2.5 micron (PM_{2.5}), sulfur dioxide (SO₂), oxides of nitrogen (NO_x), volatile organic compounds (VOC), carbon monoxide (CO), greenhouse gases (GHG) in the form of carbon dioxide equivalent (CO_{2e}), hazardous air pollutants (HAP), and toxic air pollutants (TAP). As a direct-fired combustion unit, the CDK emits pollutants from the combustion of green sawdust and the drying of the wet wood product. The majority of material handling activities for the Project are controlled and are not expected to generate fugitive emissions, including covered conveyor transfers, enclosed drops, and blow pipe transfers. However, particulate emissions are generated from a few sources as part of this project, including cyclones and unenclosed drops. Additionally, land will be paved for various uses, such as chip and bark bin truck loading, green lumber holding and staging areas, product storage, and vehicle traffic, so fugitive PM emissions will be generated from paved road activities. A summary of Project criteria pollutants, GHG, and HAP/TAP emissions is provided in NOC application submitted to ORCAA.

Since the Project includes removal of the existing batch dry kilns and hog fuel boiler, the Facility-wide potential-to-emit (PTE) represents significant reductions in VOC, CO, and NO_x emissions from the currently permitted PTE as listed in the Title V Permit 12AOP915.

See the NOC application for detailed calculations and explanation of calculation methodologies.

Demolition and construction activities for the Project will have the potential to create temporary dust emissions during earth-moving activities and exhaust emissions from the combustion of gas and diesel fuels.

b. Are there any off-site sources of emissions or odor that may affect your proposal? If so, generally describe.

There are no off-site sources of significant emissions or odor that may affect the proposal.

c. Proposed measures to reduce or control emissions or other impacts to air, if any.

According to the Best Available Control Technology (BACT) analyses conducted in the NOC application, Weyerhaeuser will use proper maintenance and operating practices as BACT for all criteria pollutant and TAP emissions. Specifically, Weyerhaeuser will install a kiln management system and in-kiln moisture management system, both of which provide for optimal drying efficiency and operating practices. Additionally, temperature has a significant impact on drying-based emissions, so Weyerhaeuser will operate the CDK with a maximum drying temperature of 200 °F to limit VOC and TAP emissions. Per the vendor's guarantee, the green sawdust gasification burners will be designed with a "secondary gas burner system with [three] individual burner chambers," as well as flue gas recirculation, so Weyerhaeuser will use combustion modifications to further control NO_x emissions. Extraction modules will also be installed at each end of the CDK to reduce potential ground level fog hazard and send the

majority of the water vapor upwards into the atmosphere.

Regarding PM emissions from unenclosed material handling activities, loading of green sawdust from the sawmill to the CDK fuel silo and loading of bark from the hog to the bark truck bins will each be controlled by a cyclone with airlocks. Transfer of dry chips from the planer mill to the chip bins will also be controlled by a cyclone with airlocks, and the cyclone exhaust will further be controlled by a baghouse with a 99% control efficiency. Weyerhaeuser will also install steel sidings on two out of four sides of the truck bin drop points, which will reduce fugitive PM emissions by 50% upon truck loading. For the new green sawdust drop point, the material transfer is located within the building enclosure, which reduces fugitive PM emissions. For paved road activities, Weyerhaeuser will continue its practice of watering and vacuuming roads bi-weekly to control 75% of fugitive PM emissions.

Destruction and construction equipment will be maintained in optimal operational conditions, idling equipment to be turned off, and dust control to be applied when necessary.

3. Water [Find help answering water questions](#)

a. Surface Water: [Find help answering surface water questions](#)

- 1. Is there any surface water body on or in the immediate vicinity of the site (including year-round and seasonal streams, saltwater, lakes, ponds, wetlands)? If yes, describe type and provide names. If appropriate, state what stream or river it flows into.**

The lumbermill site is between the Willapa River and the South Fork tributary to the Willapa River. The Willapa River discharges directly to the Pacific Ocean. No wetlands are present in the area of the lumbermill facilities.

- 2. Will the project require any work over, in, or adjacent to (within 200 feet) the described waters? If yes, please describe and attach available plans.**

The project will not require any work over or in the Willapa River, but work will be adjacent to (within 200 feet) of the river. Work within 200 ft of the river will include new and replaced asphalt pavement and associated stormwater drainage improvements, as indicated on attached Plant Modernization Schematic, Drawing 20348-902030-10, Rev B.

- 3. Estimate the amount of fill and dredge material that would be placed in or removed from surface water or wetlands and indicate the area of the site that would be affected. Indicate the source of fill material.**

None.

- 4. Will the proposal require surface water withdrawals or diversions? Give a general description, purpose, and approximate quantities if known.**

No.

- 5. Does the proposal lie within a 100-year floodplain? If so, note location on the site plan.**

No the project is not within the 100-year floodplain (source: Flood Insurance Rate Map [FIRM], map numbers 53049C0255D and 5049C0265D, effective date May 18, 2015).

- 6. Does the proposal involve any discharges of waste materials to surface waters? If so, describe the type of waste and anticipated volume of discharge.**

No waste materials are or would be discharged to surface waters. The lumbermill has a wastewater discharge permit from Ecology (State Waste Discharge Permit No. ST0006167) to discharge industrial wastewater to the Willapa Regional Wastewater Treatment Plant in Raymond.

b. Ground Water: [Find help answering ground water questions](#)

- 1. Will groundwater be withdrawn from a well for drinking water or other purposes? If so, give a general description of the well, proposed uses and approximate quantities withdrawn from the**

well. Will water be discharged to groundwater? Give a general description, purpose, and approximate quantities if known.

No

- 2. Describe waste material that will be discharged into the ground from septic tanks or other sources, if any (domestic sewage; industrial, containing the following chemicals...; agricultural; etc.). Describe the general size of the system, the number of such systems, the number of houses to be served (if applicable), or the number of animals or humans the system(s) are expected to serve.**

None

c. Water Runoff (including stormwater):

- a) Describe the source of runoff (including storm water) and method of collection and disposal, if any (include quantities, if known). Where will this water flow? Will this water flow into other waters? If so, describe.**

Project runoff would be limited to stormwater from existing structures and surfaces. Stormwater will continue to be collected in existing catch basins, go through treatment, prior to existing stormwater discharge points into the Willapa River mainstem and South Fork.

- b) Could waste materials enter ground or surface waters? If so, generally describe.**

No

- c) Does the proposal alter or otherwise affect drainage patterns in the vicinity of the site? If so, describe.**

The proposed project would not alter or otherwise affect drainage patterns to or from adjacent properties. The project would retain all of the existing pipe outfalls to the Willapa River. The only modification would be to divert stormwater (up to the treatment flow design basis) from drainage areas 2, 3, and 4 and convey that stormwater to a planned new pond that will discharge to existing Outfall 1.

- d) Proposed measures to reduce or control surface, ground, and runoff water, and drainage pattern impacts, if any.**

The proposed improvements will not adversely impact surface, ground or runoff water. See the response to the prior question for changes to site stormwater drainage.

4. Plants [Find help answering plants questions](#)**a. Check the types of vegetation found on the site:**

- deciduous tree: **alder**, maple, aspen, other: **ornamental plantings in green belt along shoreline**
- evergreen tree: **fir, cedar**, pine, other
- shrubs
- grass
- pasture
- crop or grain
- orchards, vineyards, or other permanent crops.
- wet soil plants: **cattail**, buttercup, bullrush, skunk cabbage, other: **biofiltration pond is planted with sedges, shrubs**
- water plants: water lily, eelgrass, milfoil, other
- other types of vegetation

b. What kind and amount of vegetation will be removed or altered?

No removal or alteration of vegetation is proposed at this time.

c. List threatened and endangered species known to be on or near the site.

None

d. Proposed landscaping, use of native plants, or other measures to preserve or enhance vegetation on the site, if any.

No new landscaping is proposed at this time.

e. List all noxious weeds and invasive species known to be on or near the site.

Himalayan blackberry (*Rubus bifrons*) is a Washington State Class C noxious weed (i.e., control is voluntary; eradication is not required) that grows along shoreline areas of the lumbermill. The Project would not disturb or spread Himalayan blackberry.

5. Animals [Find help answering animal questions](#)

- a. List any birds and other animals that have been observed on or near the site or are known to be on or near the site.

Examples include:

- Birds: [hawk](#), [heron](#), [eagle](#), [songbirds](#), other:
- Mammals: [deer](#), [bear](#), elk, [beaver](#), other: [river otter](#)
- Fish: bass, [salmon](#), [trout](#), herring, shellfish, other:

- b. List any threatened and endangered species known to be on or near the site.

The Willapa River supports bull trout (*Salvelinus confluentus*) (no Core Area identified, no critical habitat present), Pacific eulachon (*Thaleichthys pacificus*), and North American green sturgeon (*Acipenser medirostris*).

Birds that may be seen in the vicinity of the Project area include marbled murrelet (*Brachyramphus marmoratus marmoratus*), western snowy plover (*Charadrius alexandrinus nivosus*), streaked horned lark (*Eremophila alpestris strigata*) (Ledbetter Point is the only coastal dunes nesting area in Washington), and northern spotted owl (*Strix occidentalis caurina*) (source: WDFW PHS on the Web, accessed May 12, 2021). Northern spotted owl is listed as present within a 36-sq.-mi. area that includes the Project parcel and part of Raymond.

- c. Is the site part of a migration route? If so, explain.

The Willapa River is an anadromous fish migration route. Birds, such as marbled murrelet and northern spotted owl, also migrate along river channels. Birds such as streaked horned lark are often found in open riparian corridors along rivers. The general area is within the Pacific Flyway for migratory birds traveling between breeding and non-breeding habitat on the west coast of North and South America.

- d. Proposed measures to preserve or enhance wildlife, if any.

None needed; the Project will not affect migratory fish or birds or their associated critical habitat.

- e. List any invasive animal species known to be on or near the site.

None known

6. Energy and Natural Resources [Find help answering energy and natural resource questions](#)

- 1. What kinds of energy (electric, natural gas, oil, wood stove, solar) will be used to meet the completed project's energy needs? Describe whether it will be used for heating, manufacturing, etc.**

The energy sources for the project will include electrical only (Bonneville and local Raymond PUD – Pacific County PUD #2.1). Energy will be used for heating green lumber in the process of manufacturing a finished lumber product.

- 2. Would your project affect the potential use of solar energy by adjacent properties? If so, generally describe.**

No

- 3. What kinds of energy conservation features are included in the plans of this proposal? List other proposed measures to reduce or control energy impacts, if any.**

Equipment will be sized to ensure optimum energy requirements.

7. Environmental Health [Find help with answering environmental health questions](#)

a. Are there any environmental health hazards, including exposure to toxic chemicals, risk of fire and explosion, spill, or hazardous waste, that could occur because of this proposal? If so, describe.

No.

1. Describe any known or possible contamination at the site from present or past uses.

No known contamination at the Project site has been identified or reported.

2. Describe existing hazardous chemicals/conditions that might affect project development and design. This includes underground hazardous liquid and gas transmission pipelines located within the project area and in the vicinity.

There are no existing hazardous chemicals/conditions that are expected to affect project development and design.

3. Describe any toxic or hazardous chemicals that might be stored, used, or produced during the project's development or construction, or at any time during the operating life of the project.

No chemicals will be used or stored as part of this project.

4. Describe special emergency services that might be required.

None

5. Proposed measures to reduce or control environmental health hazards, if any.

Environmental health hazards would continue to be controlled through documented management programs, including the National Pollutant Discharge Elimination System (NPDES) Program and Stormwater Pollution Prevention Plan (SWPPP), Air Operating permit, Spill Prevention, Control and Countermeasure (SPCC) plan, etc. per federal and State regulations which are already required at the site.

b. Noise

1. What types of noise exist in the area which may affect your project (for example: traffic, equipment, operation, other)?

None

2. What types and levels of noise would be created by or associated with the project on a short-term or a long-term basis (for example: traffic, construction, operation, other)? Indicate what hours noise would come from the site)?

Diesel-powered equipment would create short-term noise during construction between the approximate

hours of 7 am and 4 pm. Vehicles would likely consist of trucks, loaders or small cranes. No discernable noises are expected after the new CDK system is in operation, as noise from the new CDK system operation would be indistinguishable from the ongoing heavy industrial equipment used to move and process logs.

The lumbermill operates continuously and would continue to generate noise from vehicle traffic and facility operations up to 24 hours per day and 7 days per week.

3. Proposed measures to reduce or control noise impacts, if any.

No proposed measures because noise from equipment delivery and installation and CDK system operation would be indistinguishable from the ongoing heavy industrial equipment used to move and process logs.

8. Land and Shoreline Use [Find help answering land and shoreline use questions](#)

- a. What is the current use of the site and adjacent properties? Will the proposal affect current land uses on nearby or adjacent properties? If so, describe.**

The site is a designated high-intensity industrial sawmill used for forest products production. The proposed improvements will not affect current, nearby, or adjacent properties' land uses.

- b. Has the project site been used as working farmlands or working forest lands? If so, describe. How much agricultural or forest land of long-term commercial significance will be converted to other uses because of the proposal, if any? If resource lands have not been designated, how many acres in farmland or forest land tax status will be converted to nonfarm or nonforest use?**

The site has been used as a lumbermill since the early 1900s and operated by Weyerhaeuser since 1931⁴. The Project would not cause conversion of any farm, non-farm, or forest land to other uses.

- 1. Will the proposal affect or be affected by surrounding working farm or forest land normal business operations, such as oversize equipment access, the application of pesticides, tilling, and harvesting? If so, how?**

No surrounding working farm or forest land normal business operations would affect or be affected by the Project.

⁴ Ott, J. 2010. Raymond—Thumbnail History. HistoryLink.org Essay #9590 accessed June 19, 2021, at historylink.org/File/9590

c. Describe any structures on the site.

Existing structures on the site consist of offices, batch kilns, several sheds, saw mill buildings, and boiler/fuel structures. The existing structures are shown and labeled on the aerial image below.

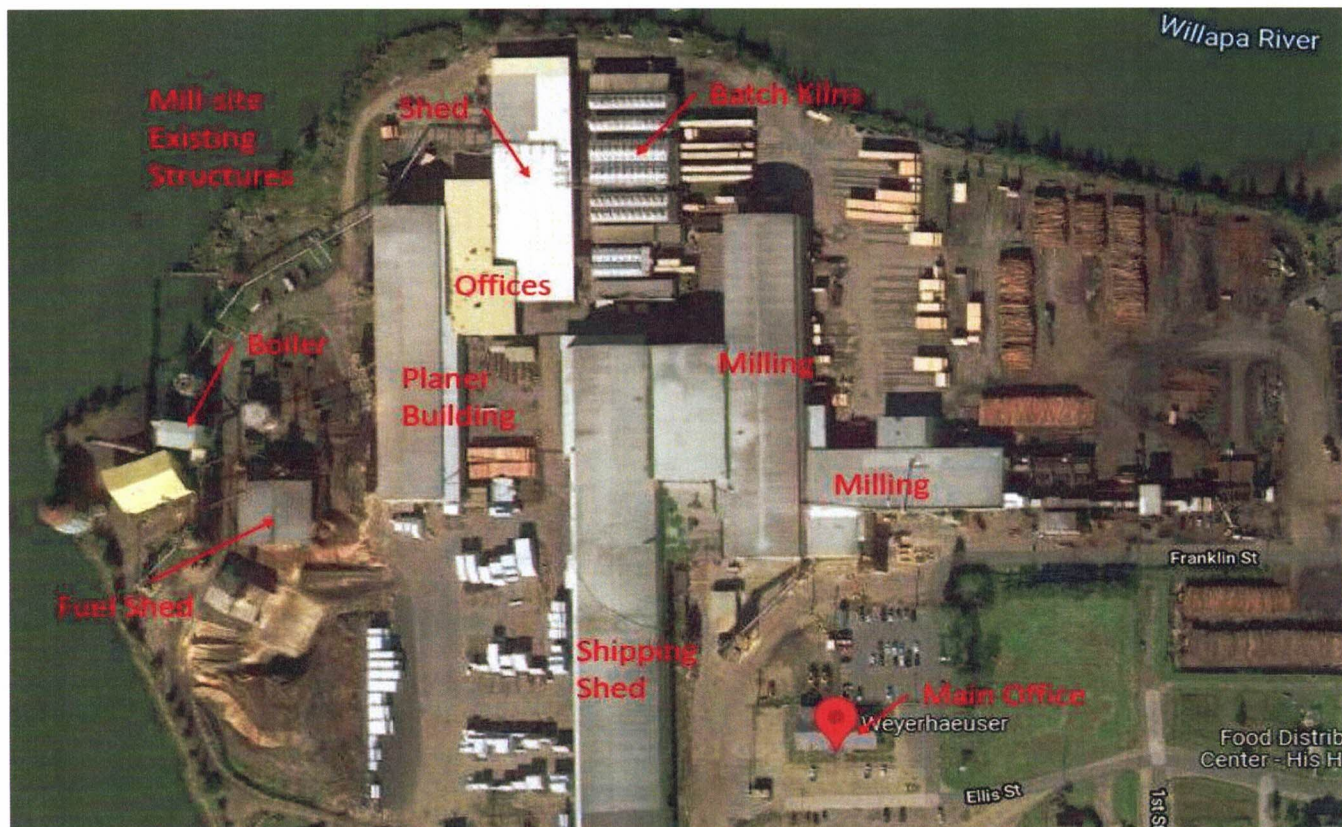

d. Will any structures be demolished? If so, what?

The powerhouse, fuel building, existing kilns, cooling shed and storeroom will be demolished. The storeroom will be replaced as part of this project.

e. What is the current zoning classification of the site?

Heavy Industrial (M-2) (City of Raymond, Washington Zoning Map, accessed June 19, 2021, at <http://cityofraymond.com/ZONING.htm>)

f. What is the current comprehensive plan designation of the site?

Heavy Industrial (M-2) (City of Raymond Comprehensive Plan Figure 2-5, October 2000)

g. If applicable, what is the current shoreline master program designation of the site?

High Intensity Environment (City of Raymond Shoreline Master Program, Shoreline Environmental Designations Appendix A. August 12, 2017)

h. Has any part of the site been classified as a critical area by the city or county? If so, specify.

Critical areas within the City Unified Development Code (Raymond Municipal Code 15.18.060.B) include wetlands, geologically hazardous areas, fish and wildlife habitat conservation areas, and frequently flooded areas.

No wetlands are mapped on the site.

The site is part of a larger geologically hazardous area for seismic hazard due to liquefaction susceptibility of fill soil, explained in section B.1.d.

The site is adjacent to the Willapa River, which is classified as “waters of the State” and therefore is a fish and wildlife habitat conservation area; however, no work will occur within the river or below ordinary high water. All work will occur on land (some work will occur within 200 ft of the ordinary high water mark).

The site is not identified by FEMA as a frequently flooded area.

The site is within a township and range identified as containing northern spotted owl habitat; however, no work will affect owls or their critical habitats.

i. Approximately how many people would reside or work in the completed project?

The mill employs 170 people.

j. Approximately how many people would the completed project displace?

This proposed project is not expected to result in the displacement of employees.

k. Proposed measures to avoid or reduce displacement impacts, if any.

For the changing operations, Weyerhaeuser expects that existing employees will be retrained as needed to be able to complete the new or modified tasks required for the new CDK operations.

l. Proposed measures to ensure the proposal is compatible with existing and projected land uses and plans, if any.

None

m. Proposed measures to reduce or control impacts to agricultural and forest lands of long-term commercial significance, if any.

None

9. Housing [Find help answering housing questions](#)

- a. **Approximately how many units would be provided, if any? Indicate whether high, middle, or low-income housing.**

No housing is or will be present on site.

- b. **Approximately how many units, if any, would be eliminated? Indicate whether high, middle, or low-income housing.**

None

- c. **Proposed measures to reduce or control housing impacts, if any.**

None

10. Aesthetics [Find help answering aesthetics questions](#)

- a. What is the tallest height of any proposed structure(s), not including antennas; what is the principal exterior building material(s) proposed?**

The tallest proposed structure (silo and associated cyclone) are approximately 120 ft tall.

- b. What views in the immediate vicinity would be altered or obstructed?**

The CDK will be behind existing buildings and should not be visible from the river side.

- c. Proposed measures to reduce or control aesthetic impacts, if any.**

Building colors and components will be similar to existing structures.

11. Light and Glare [Find help answering light and glare questions](#)

a. What type of light or glare will the proposal produce? What time of day would it mainly occur?

No change in lighting or glare is expected for this Project.

b. Could light or glare from the finished project be a safety hazard or interfere with views?

No effects expected.

c. What existing off-site sources of light or glare may affect your proposal?

None identified.

d. Proposed measures to reduce or control light and glare impacts, if any.

No measures expected to be needed.

12. Recreation [Find help answering recreation questions](#)

a. What designated and informal recreational opportunities are in the immediate vicinity?

The City of Raymond and surrounding areas offer numerous parks, open spaces, trails, and water-based recreational opportunities on the Willapa River and South Fork.

b. Would the proposed project displace any existing recreational uses? If so, describe.

No

c. Proposed measures to reduce or control impacts on recreation, including recreation opportunities to be provided by the project or applicant, if any.

None

13. Historic and Cultural Preservation [Find help answering historic and cultural preservation questions](#)

- a. Are there any buildings, structures, or sites, located on or near the site that are over 45 years old listed in or eligible for listing in national, state, or local preservation registers? If so, specifically describe.**

A brick smokestack, steel silo, wooden office building, and several wooden manufacturing buildings and sheds are over 45 years old. None of these structures would be removed. No buildings, structures, or sites near the proposed project are listed in national, state, or local preservation register information compiled by the Washington Information System for Archeology and Anthropology Data (WISAARD) database⁵.

- b. Are there any landmarks, features, or other evidence of Indian or historic use or occupation? This may include human burials or old cemeteries. Are there any material evidence, artifacts, or areas of cultural importance on or near the site? Please list any professional studies conducted at the site to identify such resources.**

The mill is located in the Willapa Bay watershed, an area previously inhabited by the Chinook, Lower Chehalis, and Kwalhiloqua peoples. The Shoalwater Indian Reservation occupies 333 acres on the north shore of Willapa Bay, on the site of an ancient Chinook village, and more than 1,000 Chinook tribal members live at Bay Center on Willapa Bay and in South Bend—both ancient village sites—and elsewhere around the region⁶. The area's federally recognized tribes of Washington State are the Confederated Tribes of the Chehalis Reservation and Confederated Tribes of the Warm Springs.

A desktop review (c. May 6, 2020) by the Washington Department of Archaeology and Historic Preservation (DAHP), using their statewide predictive model, identified the area as having very high sensitivity for prehistoric archaeological resources, due to the lumbermill location near the confluence of two rivers. However, no evidence of Indian or historic use or occupation of the lumbermill has been identified or discovered to date.

A 2020 excavation of the site in adjacent areas (for installation of a below-grade stormwater system) found no material evidence of remains of human life or activity. Prior to excavation, a site review conducted by the Department of Archaeological and Historic Preservation (DAHP) found no evidence of the likely presence of archaeological or cultural resources; therefore DAHP did not request an onsite survey or additional documentation for the project.

- c. Describe the methods used to assess the potential impacts to cultural and historic resources on or near the project site. Examples include consultation with tribes and the department of archeology and historic preservation, archaeological surveys, historic maps, GIS data, etc.**

⁵ Accessed May 15, 2021; no results in any search category for Weyerhaeuser and Raymond, 51 Ellis and Raymond.

⁶ Story, V. 2006. Pacific County—Thumbnail History. HistoryLink.org Essay 7914, posted Oct. 26, 2006. Accessed May 23, 2021, at <https://historylink.org/File/7914>.

Local tribes (presumably, the Confederated Tribes of the Chehalis Reservation and Confederated Tribes of the Warm Springs) and DAHP will be notified during the SEPA process of the proposed project and provided the opportunity to review and comment.

d. Proposed measures to avoid, minimize, or compensate for loss, changes to, and disturbance to resources. Please include plans for the above and any permits that may be required.

It is not expected that this Project will result in loss, changes to or disturbance to historic resources.

14. Transportation [Find help with answering transportation questions](#)

- a. Identify public streets and highways serving the site or affected geographic area and describe proposed access to the existing street system. Show on site plans, if any.**

The lumbermill is accessible from State Route (SR) 101 on surface streets in the City of Raymond via Ellis, Franklin, 1st and 3rd streets. The Project would not affect access.

- b. Is the site or affected geographic area currently served by public transit? If so, generally describe. If not, what is the approximate distance to the nearest transit stop?**

The Pacific Transit System provides bus service to Raymond between Aberdeen and Astoria and the communities along the route. A bus service stop is two blocks from the mill.

- c. Will the proposal require any new or improvements to existing roads, streets, pedestrian, bicycle, or state transportation facilities, not including driveways? If so, generally describe (indicate whether public or private).**

The proposed project would not require new or improved public or private roads.

- d. Will the project or proposal use (or occur in the immediate vicinity of) water, rail, or air transportation? If so, generally describe.**

The proposed project would not use water, rail, or air transportation.

- e. How many vehicular trips per day would be generated by the completed project or proposal? If known, indicate when peak volumes would occur and what percentage of the volume would be trucks (such as commercial and nonpassenger vehicles). What data or transportation models were used to make these estimates?**

None

- f. Will the proposal interfere with, affect, or be affected by the movement of agricultural and forest products on roads or streets in the area? If so, generally describe.**

No

- g. Proposed measures to reduce or control transportation impacts, if any.**

None proposed (no impacts would result)

15. Public Services [Find help answering public service questions](#)

a. Would the project result in an increased need for public services (for example: fire protection, police protection, public transit, health care, schools, other)? If so, generally describe.

No increased public service would be needed.

b. Proposed measures to reduce or control direct impacts on public services, if any.

None proposed (no impacts would result).

16. Utilities [Find help answering utilities questions](#)

- a. Circle utilities currently available at the site: **electricity**, natural gas, **water**, **refuse service**, **telephone**, **sanitary sewer**, septic system, other: **industrial wastewater**

- b. Describe the utilities that are proposed for the project, the utility providing the service, and the general construction activities on the site or in the immediate vicinity which might be needed.

Existing onsite utilities will continue to support the proposed system. Electricity will continue to be supplied by Pacific County PUD No. 2. Wastewater generated during operations will continue to be sent to the Willapa Regional Industrial Wastewater System.

Improvements are proposed for the facility's stormwater drainage and conveyance features.

C. Signature [Find help about who should sign](#)

The above answers are true and complete to the best of my knowledge. I understand that the lead agency is relying on them to make its decision.

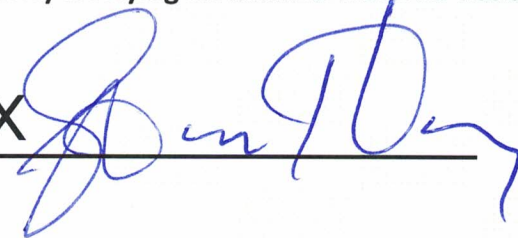
X  _____

Type name of signee: Spencer Headley

Position and agency/organization: Weyerhaeuser Lumbermill Unit Manager

Date submitted: 9/6/2023

D. Supplemental sheet for nonproject actions [Find help for the nonproject actions worksheet](#)

IT IS NOT REQUIRED to use this section for project actions.

Because these questions are very general, it may be helpful to read them in conjunction with the list of the elements of the environment.

When answering these questions, be aware of the extent the proposal, or the types of activities likely to result from the proposal, would affect the item at a greater intensity or at a faster rate than if the proposal were not implemented. Respond briefly and in general terms.

1. How would the proposal be likely to increase discharge to water; emissions to air; production, storage, or release of toxic or hazardous substances; or production of noise?

- **Proposed measures to avoid or reduce such increases are:**

2. How would the proposal be likely to affect plants, animals, fish, or marine life?

- **Proposed measures to protect or conserve plants, animals, fish, or marine life are:**

3. How would the proposal be likely to deplete energy or natural resources?

- **Proposed measures to protect or conserve energy and natural resources are:**

4. How would the proposal be likely to use or affect environmentally sensitive areas or areas designated (or eligible or under study) for governmental protection, such as parks, wilderness, wild and scenic rivers, threatened or endangered species habitat, historic or cultural sites, wetlands, floodplains, or prime farmlands?

- **Proposed measures to protect such resources or to avoid or reduce impacts are:**

5. How would the proposal be likely to affect land and shoreline use, including whether it would allow or encourage land or shoreline uses incompatible with existing plans?

- **Proposed measures to avoid or reduce shoreline and land use impacts are:**

6. How would the proposal be likely to increase demands on transportation or public services and utilities?

- **Proposed measures to reduce or respond to such demand(s) are:**

7. Identify, if possible, whether the proposal may conflict with local, state, or federal laws or requirements for the protection of the environment.

